

# EDS-2ip & EDS-4ip Oxygen System (2nd Generation)

## OPERATING & REFERENCE MANUAL

For control head firmware release 9e and above

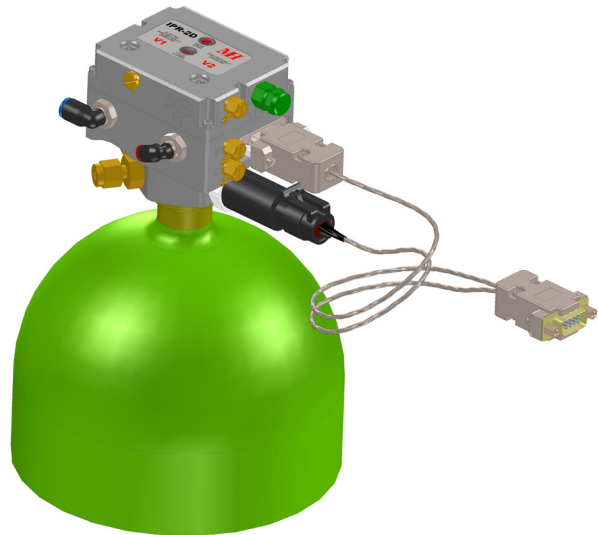
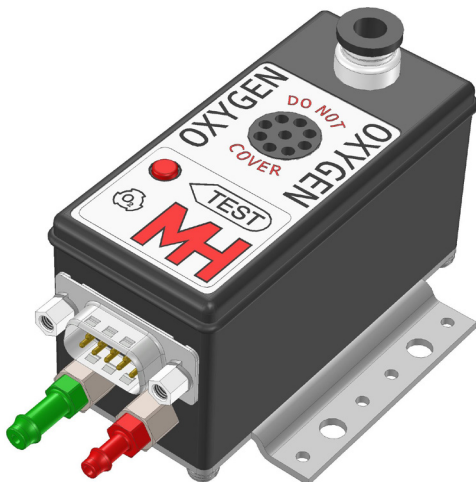

*Physiologically adaptive aviation oxygen systems utilizing patented  
EDS Pulse-demand™ and Intelligent Peripheral™ technology by Mountain High E&S*

## ***Table of Contents***

---

IP System Description	1
LCD Icons, Functions, Definitions & Meanings	2
Basic System Operation and LCD Icons	2 - 5
Turning the System ON	3
Class-A Airspace / Face Mask Mode	4
Low Tank / Cylinder Pressure Warnings	4
If the System Has a Problem	5
Emergency Oxygen Bypass Switch	5
Customizing System Settings	6
Keypad Function Guide	6
Customizing Control Head Settings	7
Customizing Station Settings	8
Oxygen Profile   Function Delivery & D Mode "Trip Point" Schedules	9
Restoring Settings to Factory Defaults	10
Calibrating the Pressure-sending Units	10
EDS Cannulas and Face Masks	11
IPR-2D Regulator Form Factor Detail & Basic Theory of Operation	12 - 13
Oxygen Distributor (Station Outlets) Description & Operations	14 - 15
Control Head Dimensions & Hole Specifications	16 - 17
Basic IPR Components & Suggested Installation Layouts	16 - 17
Reference Drawings & Technical Information	18 - 26
Basic Theory of EDS Technology   Physiological Factors	27
Materials Statement & Oxygen Safety Notice	28
Specifications	29

# EDS-ip Built-in Pulse-demand Aviation Oxygen System Description

## The EDS ip System

Congratulations on choosing the Mountain High EDS ip system, the international standard for aviation oxygen systems. The ip stands for *intelligent peripheral*, meaning each oxygen outlet station has a microcomputer that constantly monitors respiratory aspects of each person. Through the cannula or face mask, the ip system characterizes the physiological respiratory profile to adapt to individual needs and situational awareness. In addition, the ip system gleans a good approximation of a person's PaO<sub>2</sub> saturation (amount of O<sub>2</sub>-carrying blood cells that are able to carry O<sub>2</sub> to the body) ensuring that the proper amount of oxygen is delivered at various altitudes. The ip system is a completely integrated, adaptive, intelligent aviation oxygen system. No other aviation oxygen system can provide such conservation of your oxygen with unmatched safety and comfort.

## Basic ip System Configuration

- 1) The ip System Control & Display Head
- 2) Oxygen Outlets / Distributor Stations
- 3) Oxygen Source (Tank / Cylinder) & IPR regulator.
- 4) Emergency Oxygen Bypass Switch

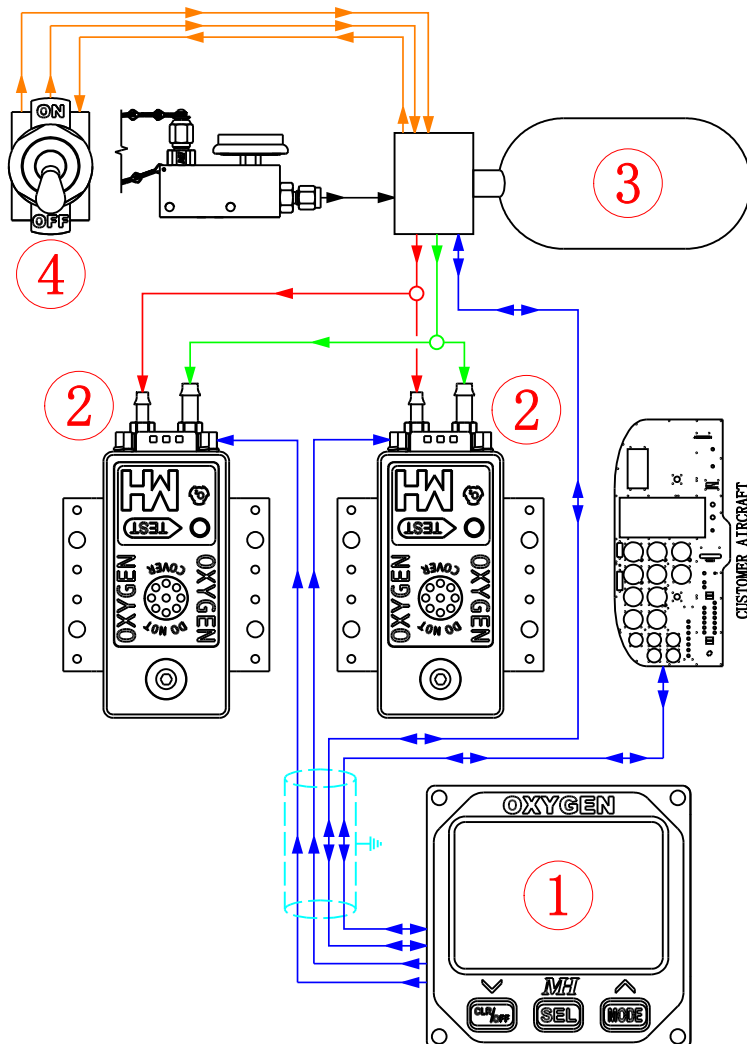

## The Benefits of a Two-stage Regulator

Our unique two-stage regulator design enables the user to get the most out of their oxygen supply tank. Older single-stage regulators required a minimum tank pressure of approximately 300-500 psi in order to provide a consistent flow and output pressure. The two-stage regulator design is able to maintain a virtually consistent pressure and flow rate all the way down to about 20 psi of tank pressure. This guarantees an additional 13%-23% duration from your oxygen cylinder.

## EDS-2ip vs EDS 4-ip

The **EDS-2ip** is a two-place system engineered to fit into the standard area for a 2.25" instrument hole.

The **EDS-4ip** is a four-place system engineered to fit into a 2.25" wide by 3.125" tall instrument hole.

Both of these lighted control heads can be configured to fit into almost any aircraft installation including an overhead console requiring only ~1.75" of depth.

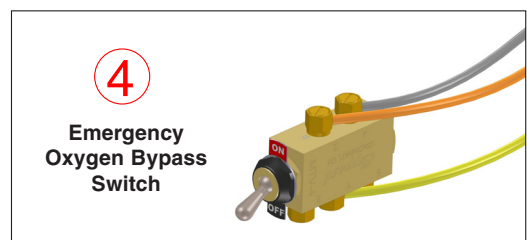
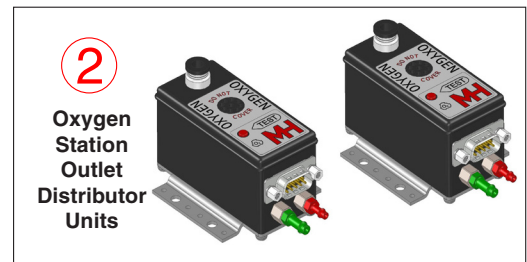
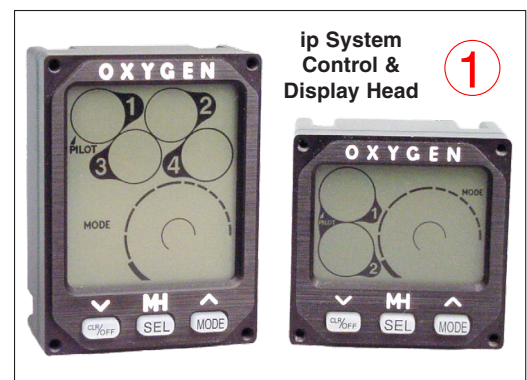

## LCD Icons, Functions & Meanings

### 2ip LCD

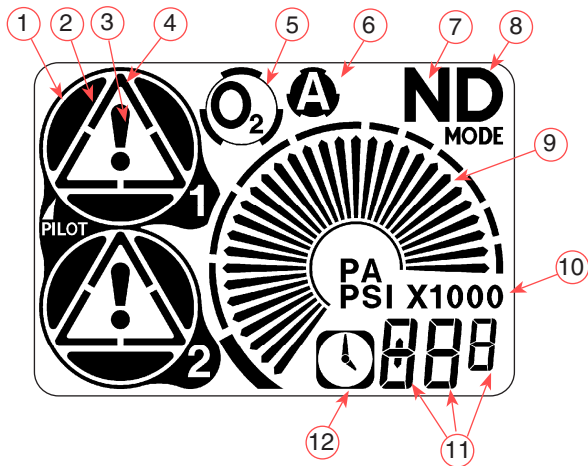

① **Station Status Circle**  
Everything unique to the stations will show up in these circles

② **Station O<sub>2</sub> Flow-flags**  
Shows station has responded with a pulse of oxygen

③ **Station Active inspiration response**  
This icon alone will show every time a valid inspiration effort has been detected or the red button has been pressed on that station DIST unit.

④ **Station Alert Icon**  
Shows for apnea, flow-faults, missing stations

⑤ **O<sub>2</sub> Alert Icon**  
Shows during situations where oxygen may not be properly delivered or where O<sub>2</sub> supply may be an issue.

⑥ **Dual-purpose Icon**  
While system is ON this icon shows that the system is operating in 'Class-A' mode, a Pressure Altitude (PA) at and above 17.5K ft. While system is OFF this icon shows that the Auto-On feature is armed to turn the system on at a PA of about 11K ft.

*This icon flashes if the system has been turned off after it came on by the Auto-on feature. Once you descend below a PA of ~10K ft. it will stop flashing to indicate that the Auto-on feature is still active and armed.*



⑦ **NIGHT (Now / Normal) Mode**  
System will respond with O<sub>2</sub> at all pressure altitudes regardless of any preset D-mode trip points. *Pages 3, 8 & 9*

⑧ **DAY (Delayed) Mode**  
System will delay response of O<sub>2</sub> until the pressure altitude is at or above the preset D-mode trip points. *Pages 3, 8 & 9*

⑨ **Analog Display**  
Complements digital readout with cylinder pressure, pressure altitude and regulator outlet pressure if the optional low-pressure regulator pressure sending kit is installed.

⑩ **Display Mode**  
Complements analog & digital display  
a) PA X1000 Pressure Altitude: 0 - 31,500 ft.  
b) PSI X100 Cylinder pressure: 0 - 3,150 psig.  
c) PSI (optional) Regulator pressure: 0 - 31.5 psig.

⑪ **Digital Read Out**  
Complements the analog display readings with numerical data. The small right-hand digit represents different scales per display mode.  
a) Hundreds (100) of ft. while in pressure altitude readout.  
b) Tens (10) of psig. while in tank / cylinder pressure readout.  
c) Tenths (1/10) while in regulator-pressure readout.

⑫ **Time / Clock Icon**  
Shows a time-constrained condition such as low O<sub>2</sub> supply alerts.

#### NOTE:

*All these icons will have different meanings during times while you are in the system or station set-up modes.*

### 4ip LCD

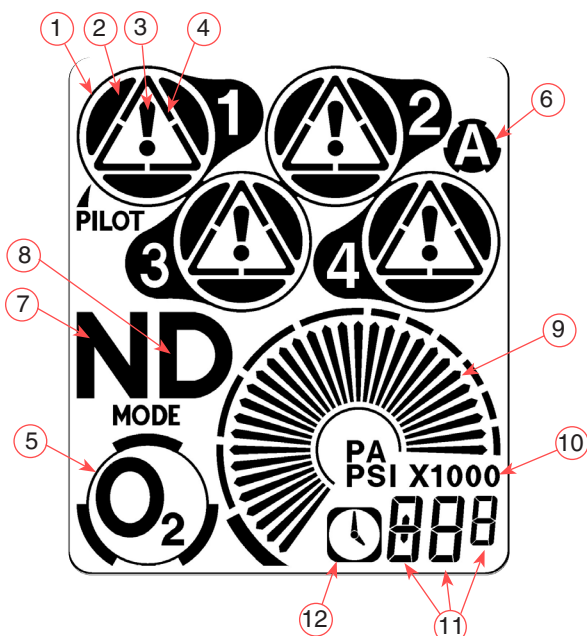

**While the system is OFF**

**Turn System ON:**

**SEL** First the control head must be connected to power and the display showing **OFF**. To turn the system on press & release the **SEL** button. The control head will light-up all the icons, perform a series of built-in tests, and proceed to operate if no problems were found.

The **SEL** button has a dual purpose while in the **OFF** state.  
 1) Press & hold to query the firmware version in the control head.  
 2) While holding the **SEL** button down, press and hold the **MODE** button to query the control head option code.

**Auto-On Feature:**

**MODE** Press & hold the **MODE** button for ~2 seconds to toggle the auto-on feature. The auto-on feature is armed if the **A** icon is on. This allows the system to automatically power-on once a pressure altitude of ~10,000 ft. is detected.



Please note that the **A** is a dual-purpose icon depending if the system is **ON** or **OFF**!  
 1) Auto-on mode armed while the system is **OFF**.  
 2) Class-A mode active while the system is **ON**.

**Actions the buttons perform are different while the system is ON or OFF.**

While On / While Off	<b>CLR/OFF</b>	<b>CLR/OFF</b>	<b>SEL</b>	<b>SEL</b>	<b>MODE</b>	<b>MODE</b>
Button Click		Clear Alerts	Power System Up	Gauge Select		Toggle D & N Modes
Button Held-Down	Clear Error Codes	Power System Down	Query Rev Level	Enter Set-up Mode	Toggle Auto-On	Toggle Class A Mode

**If the master switch is turned off while the system is on it will remember that it was on and will come back on when the master is switched back on.**

No power applied

Power applied, Off and Auto-On not armed

ON without back-lighting

ON with back-lighting

**While the system is ON**

**Turn System OFF and clearing alerts:**

**CLR/OFF** To turn the system off simply press and hold the **CLR/OFF** button until the unit shows **OFF**. This will require the button to be held down for ~2 seconds. This long hold time is by design in an effort to prevent the system from being turned off by accident. Clear any of the alert conditions such as apnea with short hits of this key.

**Special considerations with the OFF button and the Auto-on feature:**



A flashing 'A' icon, while in the OFF mode, indicates that you turned the system off at or above a PA of ~11K ft. while the auto-on feature is active. A steady 'A' icon, while in the OFF mode, indicates that the auto-on feature is armed and the system will automatically become active (turn on) once a PA of about 11K ft. is detected.



**Basic Operating Modes N & D:**

**MODE** The control head has two basic modes of operation; **N** and **D** mode. You can toggle the unit between the modes with the **MODE** key. Both modes deliver the same amount of oxygen as a function of pressure altitude.

The **N** shows you are operating in night (also called now or normal) mode and delivers oxygen on demand at all pressure altitudes. On power-up the unit defaults into the **N** mode. The system automatically goes to **N** mode and will not allow **D** mode settings if the light input indicates the lights are on. In addition, the LEDs on the distributor units act differently while the lights are on or off. See page 12 for details.

The **D** shows you are operating in Day (also called delayed) mode. The user can preselect any one of 8 pressure altitude settings from 4K ft. to 11K ft. (see setting the **D** trip points page 8). The only difference between the **N** & **D** modes is **D** mode delays delivering oxygen on demand until a certain pressure altitude is achieved.

**Analog & Digital Pressure Gauge Display:**

The control head has an analog graphical arc and digital gauge to allow the monitoring of different analog inputs. Power-on default for the gauge readout is tank / cylinder pressure.

**SEL** Press & release the **SEL** button to make analog- & digital- gauge readout selections to allow the monitoring of the following:

- a) Hundreds (100) of ft. for pressure-altitude readout.
- b) Tens (10) of psig. for tank / cylinder-pressure readout.
- c) Tenths (1/10) for regulator-pressure readout.  
Visible only if the optional regulator sending unit is installed.

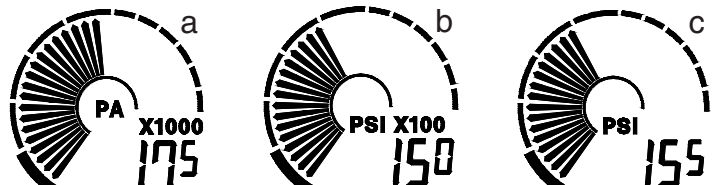

## Basic System Operation and LCD Icons

### Class-A Airspace / Face Mask Mode:

At and above a pressure altitude of about 17,500 feet, the system will automatically switch to class **A** mode. The **A** icon will flash to alert users that face masks should be used instead of cannulas. The **CLR/OFF** key will clear the alert and the **A** icon will then go on steady to indicate the unit is operating in class **A** mode. The unit will stay in the class **A** mode until a pressure altitude just below 10K ft. is detected. This function will cycle for every time you ascend and descend through these altitudes. While in the **A** mode, the active oxygen-delivery curve automatically becomes a slightly richer flow rate for use with face masks (see page 9).

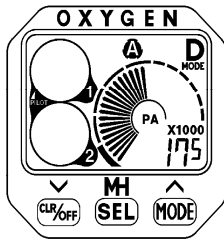

Pressing and holding down the **MODE** button for ~2 seconds will toggle the class-A airspace mode manually on or off as indicated by the **A** icon. While the system is manually placed into the class-A mode and, if the system ascends through a pressure altitude of 17,500 ft., the **A** icon will flash to alert that face masks should be used instead of cannulas.

### Low Tank / Cylinder Pressure, 1st Warning:

The EDS-ip control head constantly monitors the oxygen-cylinder pressure. If it drops to ~500 psig., it will alert that the O<sub>2</sub> is low and in a time-constrained condition, displaying the clock and O<sub>2</sub> icon and producing an audio beep (if connected to the intercom system).

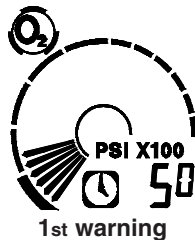

### Low Tank / Cylinder Pressure, 2nd Warning:

Once the tank pressure drops to ~200 psig, the clock icon and the O<sub>2</sub> icon will display with the O<sub>2</sub> icon flashing red. This is your second and final alert for low tank pressure. Because the IPR-2DL incorporates a two-stage regulator configuration, you can still confidently use the system down to 50 psi of tank pressure. This safety interval between 200 psi and 50 psi affords you ample time to determine a course of action.

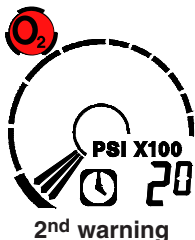

Clear these alerts via the **CLR/OFF** button. The **clock** icon will go steady at the first warning and flash on the second warning after clearing.

If the electrical cylinder-pressure sending unit fails or has become disconnected, the digital display will read -- and the bar graph will show nothing, indicating that it is not operating. The low-tank pressure 2<sup>nd</sup> warning will then alert.

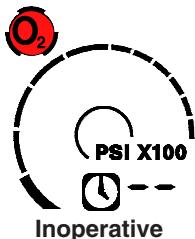

### Respiration Response:

Any one of the station status circles will flash the ! icon for each valid inspiration event detected. No oxygen is dispensed in association with this icon. It will be common while in the **D** mode and operating below the preset pressure-altitude trip point indicating that a station is operating.



### Flow Response & Idle:



Any one of the station status circles will show a steady 3-point crescent icon. Icon 1 will show for about 2 seconds for each valid inspiration event detected and complemented with oxygen. In the event that an additional inspiration effort is detected before another flow response is allowed, the '!' will show icon 2. This will be quite normal and simply indicates that the person on that station is breathing over the maximum allowable respiration rate. Icon 3 indicates an idle station.

### Oxygen Flow Fault:



Any one of the station status circles will show the ISO alert icon in association with the Oxygen Alert icon for about 3 seconds along with an audio chime after an inspiration effort where oxygen did not flow when it otherwise should have. This is called the flow-fault alert and can be from any of the following reasons:

1. The oxygen supply has been removed, turned off or has run empty.
2. The supply line has become pinched off, disconnected, obstructed or the primary regulator has failed.
- 3) The station unit has failed.

### Apnea Alert:



Once a station has been put into use and it has not detected any inspiration efforts for a period of ~40 seconds, the unit will display the apnea alert icon and produce audio beeps through the intercom system in an effort to inform the user. Resuming respiration will automatically clear the apnea alert and oxygen will continue to flow on demand. Apnea alert for any of the stations can be cleared with the **CLR/OFF** button.

*Apnea is the most common alert encountered and can be caused by any of the following reasons:*

1. The feed tube to the cannula or face mask is pinched or obstructed or the outlet (cannula) tube has become disconnected, removed or not correctly placed on the person.
2. That station has detected a pressure altitude that requires the use of oxygen, but is not being used.
3. The device has not detected breathing for over 40 seconds (This can be due to the user breathing through their mouth.)

While the system is operating in **D** mode and if you do not already have the cannula or face mask on and connected to a station, the apnea alert will remind you to put on your oxygen once the system detects a pressure altitude at or past the preset **D**-mode setting.

**If the System Has a Problem**

During cold power-up (master switch on and power applied to the unit), the system performs a series of built-in tests (BIT) then prepares itself for use. If the unit was on (active) in the past, it will go directly into the on (active) state and defaults to the **N** mode, else it will only display 'OFF'. The initialization (start-up) routine establishes communications with each O<sub>2</sub> distributor unit and powers up the Remotely Controlled Regulator unit (RCV-RCR or IPR). The control head issues a start-up command to each station in sequence starting with station one. At this point, each station distributor unit performs a BIT. A blast of O<sub>2</sub> will indicate that each station is ready. After all stations have demonstrated their readiness, the system is ready for preflight test and use.

If the control head BIT (built-in test) encounters a problem internally during power-up or run time (such as an internal system error or issue with the electrical power connections to the O<sub>2</sub> distributor units), the control head will immediately shut down (like a breaker switch) and clear the LCD display, showing only the letters Err (general error) or Er4 (low input voltage) on the LCD. In addition, the O<sub>2</sub> icon will glow red. This condition can be cleared with the **CLR/OFF** button. Error conditions will cause the ALM signal for an enunciator panel to go low.

To clear this error message push the **CLR/OFF** button. The system will then show **OFF**. If O<sub>2</sub> is needed, use the emergency O<sub>2</sub> bypass switch.

*At any time during use, if a station is not able to communicate with the control head, the status circle will constantly flash the alert icon. All other stations will operate normally.*



During initial installation, it is not uncommon to have the electrical power bus to one or all distributor units shorted, any of the distributor units to have the power pins reversed, or the send (Tx) and receive (Rx) pins be reversed.

Stations not in use will not dispense any O<sub>2</sub>. They will, however, automatically become active once they are put into use dispensing O<sub>2</sub> on demand.

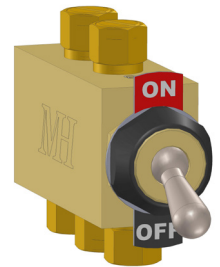
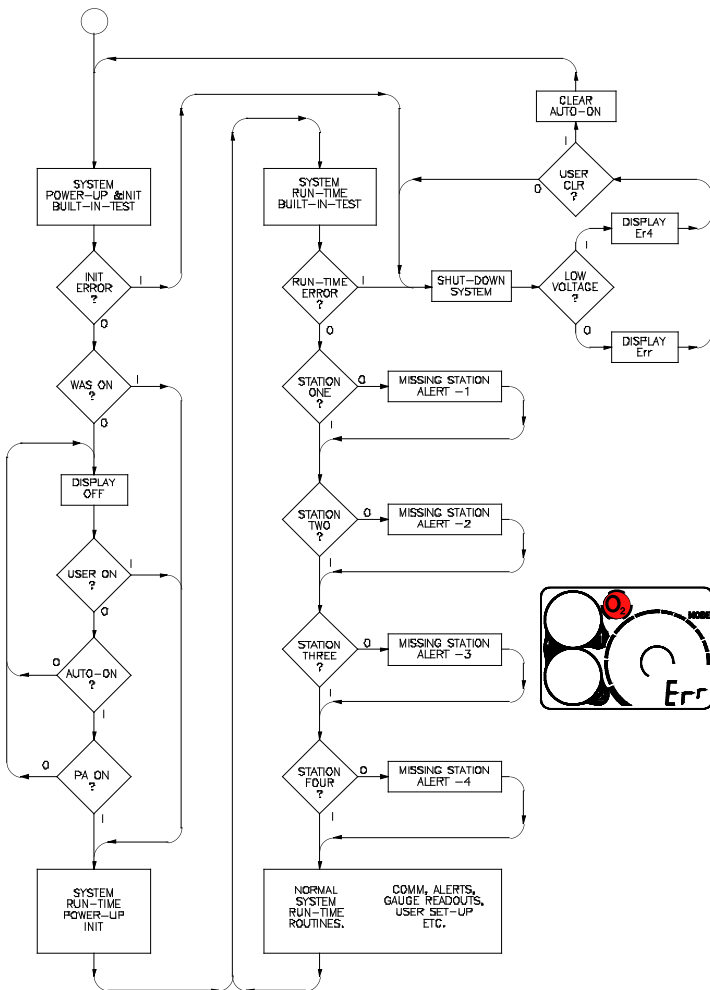

**Emergency Oxygen Bypass Switch**

A pneumatic toggle switch placed in the 'ON or EMERGENCY' position controls a separate bypass valve that provides O<sub>2</sub> to all stations at a constant flow of ~2.8 - 3.1 liters/min. **This is a completely separate system not depending on the control head or the normal supply circuit of oxygen.** While the emergency switch is in the 'NORM or OFF' position no O<sub>2</sub> is provided to the stations through the emergency bypass circuits. The emergency bypass switch can be toggled back and forth as many times as desired for testing and familiarization purposes.

Only low-pressure O<sub>2</sub> is allowed to travel to the distributors through the emergency bypass pneumatic circuit, completely bypassing the pulse-demand pneumatic circuit.

**You can cycle the system on and off in an attempt to clear the error. However, if the error condition does not clear and O<sub>2</sub> is needed, the system should be turned off and the emergency O<sub>2</sub> bypass switch should be used. The system should be serviced as soon as possible after landing.**

## Customizing System Settings

Settings for the control head can be customized for each installation or desired effect. They are: LCD contrast, LCD back-light balance with aircraft lighting, keypad backlight balance and audio volume. While you are in any of these setting modes, the system will continue to operate responding to users and delivering oxygen normally. However, if at any time a critical error occurs while you are in any of the setting modes, you will be immediately kicked out of the settings mode and sent back to normal operating mode so that the error can be interpreted and the correct action can be taken.

### Keypad Function Guide

To enter the settings mode (only accessible while the system is on), press and hold **(SEL)** the button and then press the **(CLR/OFF)** or **(MODE)** button within one second. To leave any of the setting modes, simply press and hold the **(SEL)** key for about three seconds. The unit will store any changes you have made and resume displaying your operational situation. If the control head does not detect any key button actions for 15 seconds, it will revert back to the normal operating mode and save any changes you have made. You will notice how there is a down arrow over the **(CLR/OFF)** key and an up arrow over the **(MODE)** key. You can also glide up or down through the settings by pressing and holding down either the **(MODE)** or the **(CLR/OFF)** key.

WHILE HOLDING  
THE **(SEL)** BUTTON DOWN  
PRESS & RELEASE  
THE **(MODE)** BUTTON  
TO ROTATE THROUGH THE  
SETTINGS MENU



- 1: Settings for station 1
- 2: Settings for station 2
- 3: Settings for station 3
- 4: Settings for station 4
- 5: Control head settings

WHILE HOLDING  
THE **(SEL)** BUTTON DOWN  
PRESS & RELEASE THE  
**(CLR/OFF)** BUTTON TO ROTATE  
THROUGH THE SETTINGS  
MENU IN REVERSE

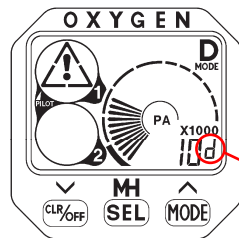

#### Station Settings

Single press the **(SEL)** button to step through the station settings. Use the arrow keys to adjust the setting level (see page 7).

Setting Indicator	Setting Level (Default Shown)
<b>d</b>	1: D-mode trip point settings <b>7</b>
<b>F</b>	2: Face mask settings <b>+2</b>
<b>P</b>	3: Profile of PA curve settings <b>0</b>
<b>r</b>	4: Respiration rate settings <b>22</b>

#### Control Head Settings

Single press the **(SEL)** button to step through the control head settings. Use the arrow keys to adjust the setting level (see page 8).

Setting Indicator	Setting Level (Default Shown)
<b>E</b>	1: LCD Contrast settings <b>15</b>
<b>L</b>	2: LCD backLight settings <b>15</b>
<b>E</b>	3: kEypad backlight settings <b>15</b>
<b>A</b>	4: Audio volume settings <b>15</b>



**Customizing Station Settings** (Refer to charts on page 9.)

Normally you will leave these at the default settings. They are, however, accessible for unique situations and applications. To do so, press & hold the **SEL** button and while doing so (within ~2 seconds) press and release the **MODE** key once to go directly to the settings menu for station one (1) or twice for the settings menu for station two (2). A third time will go to the control-head settings menu in the 2ip. In the 4ip it cycles through stations 3 & 4 and then to the control head settings. You can then cycle back to the station settings with more pressing of the **MODE** key. In fact, you can cycle through these menus in either direction with the **MODE** and **CLR/OFF** keys. Once at the desired station menu, you can select one of four items unique to that station with the **SEL** key. At this point the **CLR/OFF** key reduces the setting level and the **MODE** key increases the setting level.

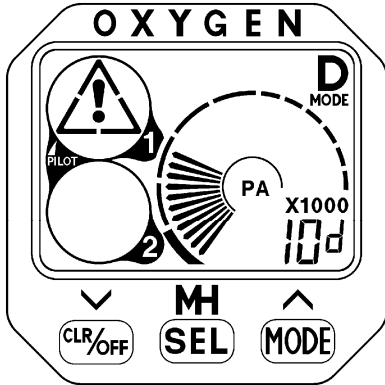

**1- The D (Day or Delayed Operations) Trip-point Settings:**

With the up & down buttons (**CLR/OFF** & **MODE**), you can select the pressure altitude at which the station will begin to deliver oxygen. Eight settings are available from 4K ft. to 11K ft. Once a pressure altitude is selected, that station will only deliver oxygen at the set pressure altitude or higher. Stations not in use will only become active once they detect valid respiration efforts.

The **D** mode is intended for daytime flight operations. In this mode, the station delays oxygen delivery until this preset pressure altitude is detected (set by the user), at which time the system operates normally, just as in the **N** mode.

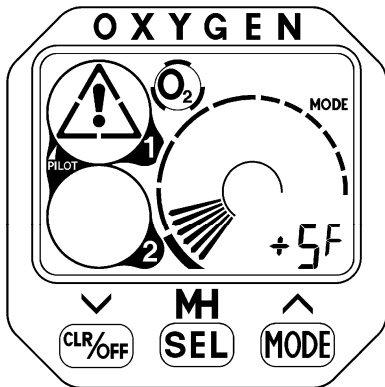
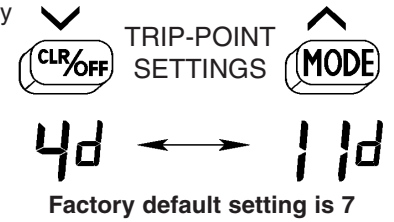

**2- Setting Oxygen Delivery for Face Mask Operations:**

This setting is used to augment how the station delivers oxygen as a function of pressure altitude only while the system is in the **A** mode. There are 8 different curves (0 through +7) you can select. This will be necessary if a face mask is used for altitudes above 18,000 ft. Depending on the face mask and the person, settings from 2 to 4 will be normal. EDS face masks use a setting of 2.

The use of a pulse oximeter may be used to determine optimum settings in unique situations and applications. Smaller settings yield a less radical function curve. Larger settings yield a more radical function curve. (See page 9 for a graphical representation.)

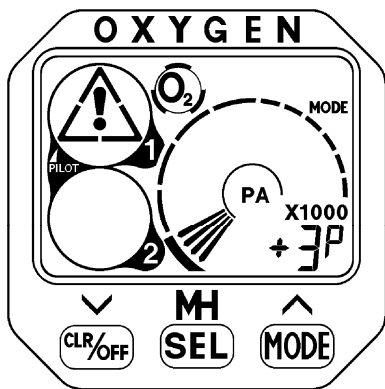
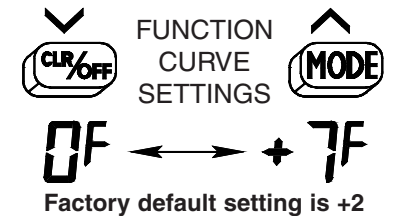

**3- Setting the Oxygen-delivery Profile (As a Function of Pressure Altitude):**

This setting allows you to change how much oxygen will be delivered as a function of pressure altitude. It is intended to allow you to compensate for those who may need more oxygen. There are eight (8) different curves (0 through +7) you can select. Each setting is ~12.5% more than the previous as a function of altitude. Once a pressure altitude of ~17.5K ft. is detected, the unit will add the contents of the **P** curve to the contents of the **F** curve (**P+F**) for flight operations in class-A airspace suitable for compensating plenum area associated with face masks.

The use of a pulse oximeter may be used to determine optimum settings in unique situations and applications. Smaller settings yield a less radical function curve. Larger settings yield a more radical function curve. (See page 9 for a graphical representation.)

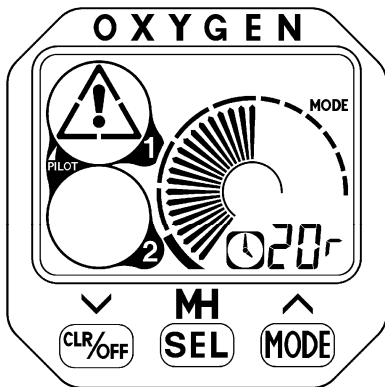
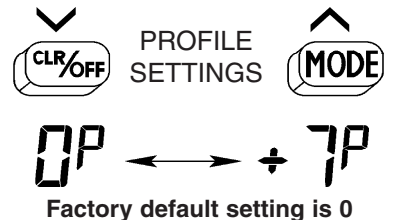

**4- Setting 'R' Respiration Rate Limit:**

This setting allows you to adjust the maximum allowable respiration rate for that station. The range is 20 breaths per minute to 30 breaths per minute in eight (8) different steps defined as (20, 21, 22, 23, 24, 26, 28, 30). If you have a station set to allow 20 breaths per minute and you are actually breathing at say, 25 breaths per minute, the station will clip and allow (respond with) something less than your actual 25 breaths per minute. If clipping becomes an issue, you can make adjustments to accommodate this.

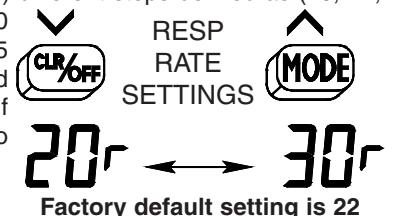

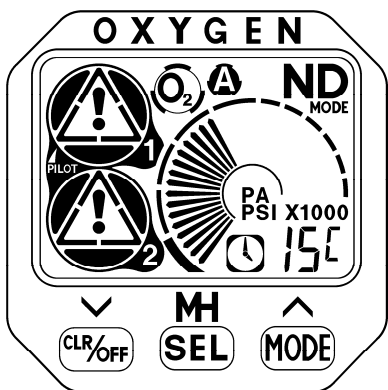

### 1- Adjusting the LCD Contrast:

You can adjust LCD contrast for best viewing contrast while observing the unit at different angles. To do so, press & hold the 'SEL' button and while doing so (within a period of ~2 seconds) press and release the **CLR/OFF** key. You will go directly to the control-head settings. You should see the LCD display as shown.

Release the **SEL** button. You can now increase the LCD contrast with the **MODE** key or decrease the LCD contrast with the **CLR/OFF** key.

While you are in this settings mode you can move through the LCD backlight balance, button backlight balance and audio-volume-adjustment modes with the **SEL** button.

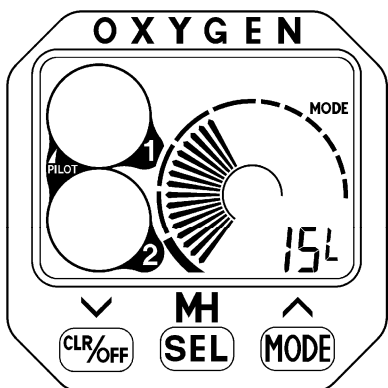
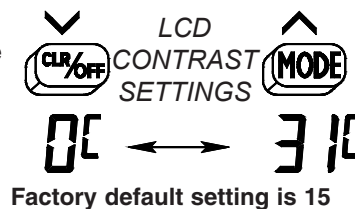

### 2- Adjusting the LCD Backlight Balance:

You can balance the brightness of the LCD backlight in 32 increments with the overall panel independent of the other instruments. To do so, press & hold the **SEL** button and while doing so, and within a period of ~2 seconds, press and release the **CLR/OFF** key. You will go directly to the LCD contrast-adjustment menu. Press & release the **SEL** key once to go to the desired LCD backlight balance setting. You can now increase the LCD backlight with the **MODE** key and decrease the LCD backlight with the **CLR/OFF** key.

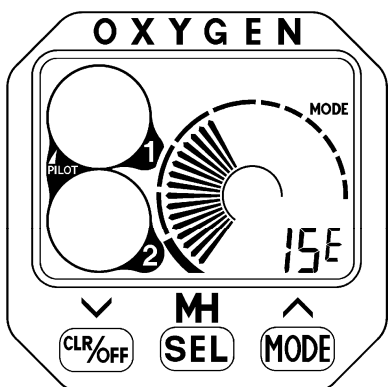
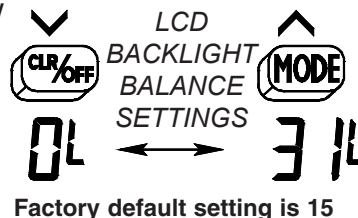

### 3- Adjusting the Keypad Backlight Balance:

You can balance the brightness of the keypad backlight in 32 increments with the overall panel independently of the other instruments. To do so, press & hold the **SEL** button and while doing so, and within ~2 seconds, press and release the **CLR/OFF** key. You will go directly to the LCD contrast-adjustment menu. Press & release the **SEL** key twice to go to the desired keypad backlight balance setting. You can now increase the keypad backlight with the **MODE** key and decrease the keypad backlight with the **CLR/OFF** key.

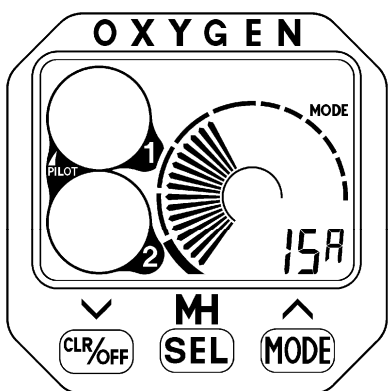
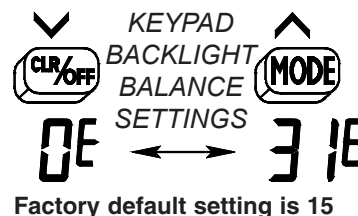

### 4- Adjusting the Audio Volume:

You can adjust the audio volume from silence (off) to full volume in 32 linear increments. To do so, press & hold the **SEL** button and while doing so (within a period of ~2 seconds) press and release the **CLR/OFF** key. You will go directly to the LCD contrast-adjustment menu. Press & release the **SEL** key three more times to go to the desired audio-volume-setting menu. You can then increase the audio volume with the **MODE** key and decrease the audio volume with the **CLR/OFF** key.

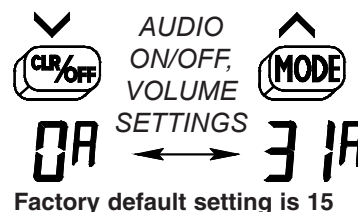

# Oxygen Profile & Function Delivery Schedule and D Mode 'Trip-point' Schedules

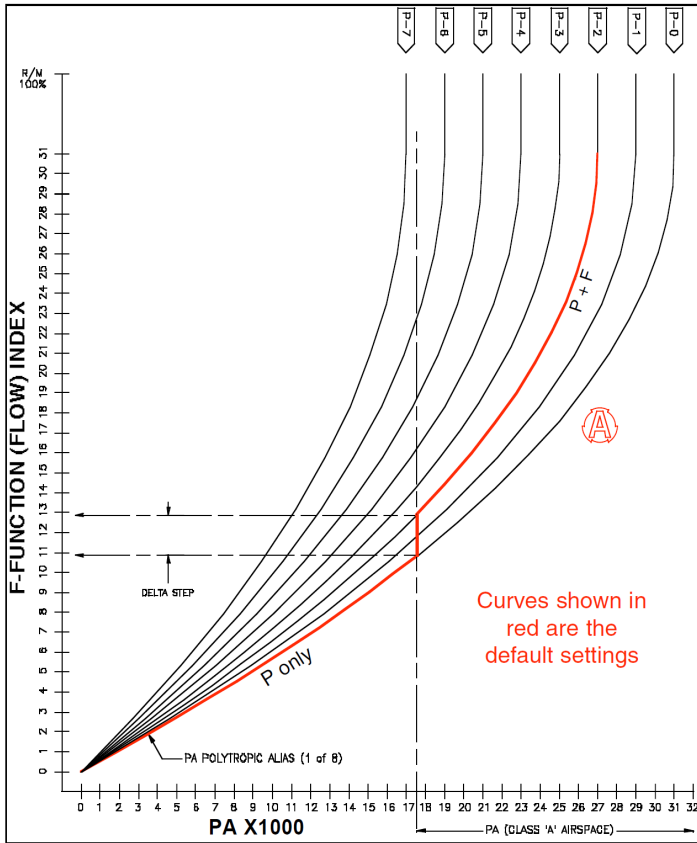

The EDS-ip system continuously monitors pressure altitude. Once a pressure altitude of ~ 17.5K ft. is detected, it will automatically go into the 'A' mode and will display the 'A' icon indicating that it is operating in class-A airspace.

While operating below a pressure altitude for class-A airspace, the current 'P' curve setting is used to schedule oxygen out as a function of pressure altitude.

Once the unit is operating within the pressure altitude of class-A airspace, the current 'P' curve settings and current 'F' settings are added together (P+F) to yield a richer flow schedule suitable for face mask operations.

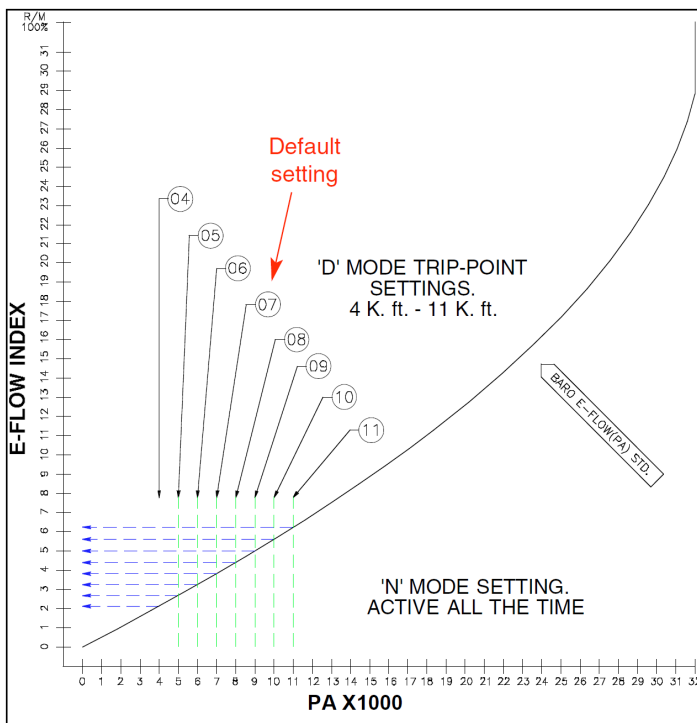

The use of a pulse oximeter may be used to determine optimum settings in unique situations such as with persons who are elderly and/or are known to have respiratory issues.

Smaller settings yield a less aggressive curve (leaner with altitude).

Larger settings yield a more aggressive curve (richer with altitude).

## ***Restoring Settings to Factory Defaults***

---

### ***To restore the system settings to the factory defaults:***

---

While the control head is in the **OFF** state, press and hold the **CLR/OFF** button for about 3 seconds. Then, while still pressing the **CLR/OFF** button, press and release the **SEL** button. You will see that the **OFF** will change to **dEF** (for defaults). Now press and hold the **SEL** button. The unit will graphically display a counterclockwise countdown sweep while doing this. Once the countdown is finished and none of the buttons have been released, the memory of the settings will be changed to the factory settings. The buttons can now be released.

For the **control head** settings: **C**ontrast = 15, **B**ackLight = 15, **K**Eys = 15, **A**udio = 15

For each of the **station** settings: **D**ay = 7, **F**acemask = 2, **P**rofile = 0, **r**espiration rate = 22

**NOTE:** If you should let the **CLR/OFF** button release at any time in this mode, the unit will go back to the **OFF** state without making any changes to the memory settings. Therefore, you must hold the **CLR/OFF** button down the entire time while doing this action. If you should press the **SEL** button twice and the display shows **CAL**, press and release it once more to get back to the **dEF** display.

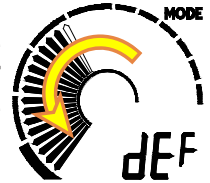

## ***Calibrating the Pressure Sending Units***

---

The tank and optional regulator pressure gauges operate electronically and are pre-calibrated, zeroed, with a 4mA standard at the factory and should work with almost any standard 4-20mA sending unit in the pressure range suitable for the display. Therefore, you should not need to perform this calibration in the field. However, if an electronic sending unit is replaced and shows an erroneous offset, calibration may be the solution.

A signal is sent from the sending unit in the form of DC current that corresponds to the pressure being sensed. That is, 4mA equals 0 (zero) and 20mA equals full-scale pressure. Ranges are 0-3,000 psig. for tank and 0-32 psig. for regulator. A current below 4mA with no pressure applied will constitute a faulty sending unit. No current measured at all will constitute a disconnected sending unit. In this case, the graphical display will show nothing and the digital readout will simply respond with '- -'. However, with your initial installation if the gauge does not read at zero or simply shows '- -', the most likely reason would be from wiring errors.

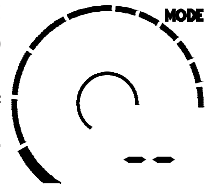

### ***To zero / recalibrate the gauge inputs:***

---

This procedure will attempt to calibrate (zero) both gauge inputs. Make sure that you have either a 4mA current standard connected into each gauge input or have a set of good known pressure sending units connected. **Make sure that there is no pressure being applied to any of the sending units during this procedure.**

While the control head is in the **OFF** state, press and hold the **CLR/OFF** button for about 3 seconds. Then, while still holding the **CLR/OFF** button down, press and release the **SEL** button twice. You will see that the **OFF** will change to **dEF** (for defaults) then **CAL** (for calibrate). The **SEL** button toggles between the two.

To calibrate the gauge inputs, press and hold down the **SEL** button while **CAL** is displayed. The unit will graphically display a counterclockwise countdown sweep while doing the calibration. If the **CLR/OFF** button has not been released, during the countdown, the control head will be calibrated from the 4mA input from the sending unit as zero and will be stored into flash memory. The unit will then go back to the **OFF** state if both inputs calibrated successfully.

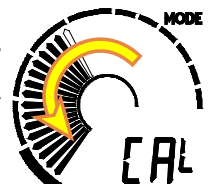

**NOTE:** If you should release the **CLR/OFF** button at any time in this mode, the unit will go back to the **OFF** state without recalibrating. Therefore, you must hold the **CLR/OFF** button down until the countdown sweep has completed.

**NOTE:** If there is not a 4mA standard present or if the input current is under or over a certain range for the gauge inputs during this procedure, it will reject that input calibration process and the original setting will be used for the zero offset. In addition, a calibration reject code will be displayed rather than the **OFF** message to inform you that you do not have the correct input current standard (4mA). The calibration reject codes are: **Cr1** = gauge input one (1) was rejected, **Cr2** = gauge input two (2) was rejected, **Cr3** = both gauge inputs one & two (1 & 2) were rejected. This code message will be displayed until you release either the **CLR/OFF** or **SEL** button.

**NOTE:** In standard configurations, only the tank pressure transducer is used. Therefore, you will always see **Cr1** after every calibration command. This is because nothing is normally connected to gauge input one (the optional regulator pressure monitor) and that input will always be rejected from the calibrate command.

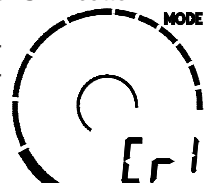

***EDS Cannula (Standard Issue)***



Cannulas supplied with the EDS-ip systems are specifically selected to operate with the EDS-ip system. They complement the physiological needs of a person for flight operations from sea level to the edge of class-A airspace, 18,000 ft. The EDS cannulas are silicone molded with a 4-foot length of high-quality PVC tubing and fitting. They fit to the face with a set of over-the-ear feed tubes to accommodate almost any face. Beards and mustaches will not compromise the delivery properties of cannulas in general. However, even the slightest amount of nasal congestion

can. Therefore, it is advisable that a face mask be used in the event nasal congestion.

In most cases the standard-tip cannula suits the needs of most people, while the flare-tip type may be needed to fit a large person or one who has large nasal openings. Standard-tip cannulas are issued by default unless otherwise stated at time of purchase.

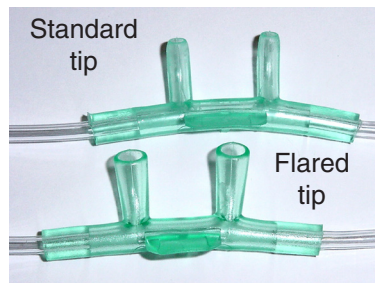

*The EDS cannula is a personal device and should not be shared between persons. In addition, it is the only item in the system that should be replaced frequently, because even with the best cleaning efforts, bacteria and such can contaminate the cannula and pose a health risk.*

***Optional: E-Z Breathe Boom Cannula***



The EZ Breathe Cannula is a headset-mountable cannula system that can be used with the EDS-ip system. The E-Z Breathe nylon boom arm affixes to your headset with a ball mount and adhesive pad. It can swivel, bend and slide in and out for best fit. The new improved arm incorporates an adjustable friction lock to eliminate slippage. The nasal tips and the entire feed tube assembly are easily replaceable, as is the aluminum mount ball. The arm can be easily removed from the headset when not in use.



***EDS Face Mask (Standard Issue)***

The standard issue EDS face masks supplied with the EDS-ip systems are specifically selected to operate with the EDS-ip system. They complement the physiological needs for flight operations from sea level through pressure altitudes up to 25,000 ft. However, if flight operations are frequent at these altitudes, one should consider using the **Deluxe** EDS face mask. They are supplied with a 1-meter length of high-quality PVC tubing and fitting.



*Face masks should be on board in the event someone should develop nasal congestion where a nasal cannula would fall short in performance.*

***Optional: Alps EDS Face Mask (With or w/o Mic)***

Oxygen admission port with swivel quick disconnect fitting



Voice port or optional microphone

Ambient air admission port

Oxygen feed tube to distributor unit

Expiratory valve port

The Alps EDS face mask is specifically designed to operate with the EDS-ip system. They complement the physiological needs of a person for flight operations from sea level through pressure altitudes up to 30,000 ft. They have a four-point detachable clip system with two independently adjustable straps to accommodate almost any face. "J" bracket helmet systems are also available. Beards and mustaches will compromise the sealing properties of face masks in general. These face masks can be cleaned with mild detergents and water.



Alps mic cable



Alps microphone

The Alps EDS face masks have a voice-port so vocal communication is possible without mask removal. The microphone of a head-set can be placed close to the voice-port and used with satisfactory results. The Alps EDS face mask can be ordered with an optional noise-canceling electret-condenser microphone & cord set compatible with most com & audio systems in place of the voice port. Please specify during ordering.

1 2 3 4

**NOTES:**

- ALL DIMENSIONS ARE IN INCHES.
- SEE EDS 2IP-4IP MANUAL FOR DETAILED OPERATION AND INSTALLATION SPECIFICATIONS.
- SEE EDS 2IP-4IP FOR WIRING SCHEMATICS
- IN HIGH-PRESSURE INTERFACE SECTION, ALL FOUR SAE-4 FITTING LOCATIONS ARE INTERCHANGEABLE. STOCK CONFIGURATION IS SHOWN

**CUSTOMER INTERFACE**  
 CABLE: CONNECT TO THIS CABLE CUSTOMER END ONLY, DO NOT INTERFACE DIRECTLY WITH THE DE-09 ON THE IPR BODY

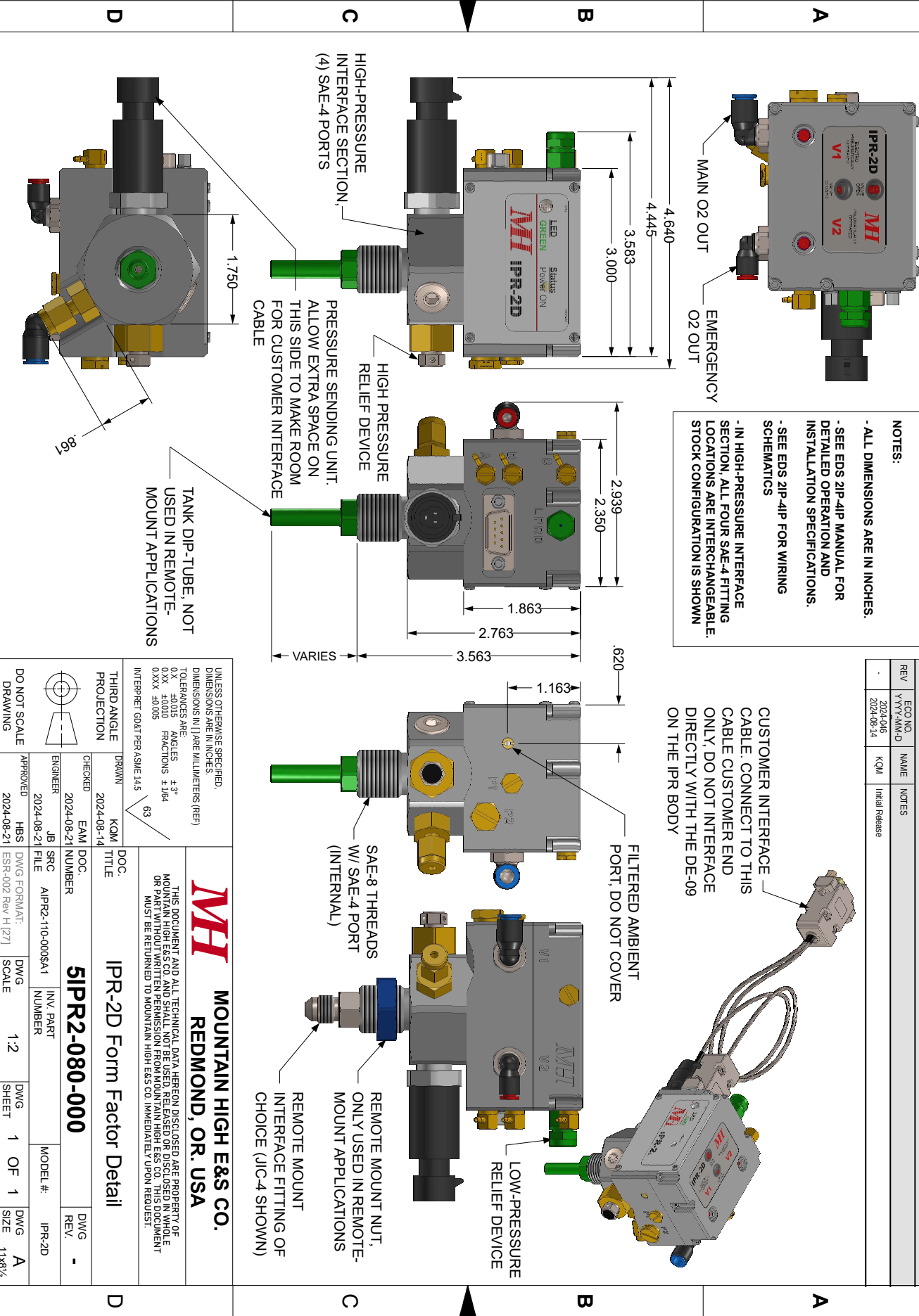

REVISION HISTORY			
REV	ECO NO.	NAME	NOTES
-	2024-046	KCM	Initial Release
-	2024-08-14	KCM	Initial Release

UNLESS OTHERWISE SPECIFIED, DIMENSIONS ARE IN INCHES. DIMENSIONS IN [ ] ARE MILLIMETERS (REF)

TOLERANCES ARE:  
 ANGLES ±3°  
 0.XX ±0.010 FRACTIONS ±.1/64  
 0.XXX ±0.005

INTERPRET GO&T PER ASME Y14.5

**MOUNTAIN HIGH E&S CO.**  
**REDMOND, OR, USA**

THIS DOCUMENT AND ALL TECHNICAL DATA HEREIN DISCLOSED ARE PROPERTY OF MOUNTAIN HIGH E&S CO. AND SHALL NOT BE USED, RELEASED OR DISCLOSED IN WHOLE OR PART WITHOUT WRITTEN PERMISSION FROM MOUNTAIN HIGH E&S CO. THIS DOCUMENT MUST BE RETURNED TO MOUNTAIN HIGH E&S CO. IMMEDIATELY UPON REQUEST.

DOC. TITLE	DOC. NUMBER	REV.
IPR-2D Form Factor Detail	5IPR2-080-000	-

APPROVED	DESIGNED	CHECKED	DATE
HBS	HBS	HBS	2024-08-21

ENGINEER	SRC	APP'D	DATE
JB	APR2-110-000SA1	ESR	2024-08-21

SCALE	SHEET	OF	DWG. SIZE
1:2	1	1	11x8 1/2"

## **General Description:**

The IPR-2DL (Intelligent Peripheral Regulator - (2nd Generation) Legacy) is an oxygen regulator specifically designed to work with the EDS 2ip-4ip pulse-demand built-in oxygen system. The IPR-2DL is a 2-stage electro-pneumatically controlled regulator that provides a constant flow of regulated oxygen to EDS intelligent distributors. The IPR-2DL also contains a redundant pneumatically-actuated emergency oxygen backup system, which when activated provides a constant flow of regulated oxygen to the emergency oxygen ports of the EDS intelligent distributors via a completely separate line. The 2-stage regulator design enables the user to get the most out of their oxygen supply tank. Older single-stage regulators required a minimum tank pressure of approximately 300-500 psi in order to provide a consistent flow and output pressure. The 2-stage regulator design is able to maintain a virtually consistent pressure and flow rate all the way down to about 20 psi of tank pressure. This guarantees an additional 13%-23% duration from your oxygen cylinder.

## **IPR-2DL Method of Operation / Technical Description:**

The IPR-2DL can be either directly mounted to the top of your oxygen tank via the SAE-8M threads, or optionally remote-mounted via hard-line copper tubing or braided flex-line, utilizing the SAE-4F port located directly inside the SAE-8M threads. In either case, high pressure O<sub>2</sub> enters the bottom of the IPR-2D where it encounters four unregulated SAE-4F ports, and the bottom of the internal 2-stage regulator. The unregulated SAE-4F ports contain the Remote-Fill Station, High Pressure Relief Device (HPRD), and Electronic Pressure Transducer (Pressure Sending Unit). The unused port can be used for other peripherals the customer may require, otherwise it will contain an SAE-4M port plug. The four unregulated ports are identical in function, therefore the high pressure peripherals can be installed in any port. After passing through the 2-stage regulator, the oxygen is now at approximately 15 psi. The regulated O<sub>2</sub> is then sent to the Main Valve Piston (MVP), and the Emergency Valve Piston (EVP). When the IPR-2DL is switched on, an electro-pneumatic valve allows a small amount of the regulated oxygen to be sent to the lower plenum of the MVP, which holds the piston open and allows the main supply of regulated oxygen through the IPR-2DL "V1" port. At the same time, a second electro-pneumatic valve allows a small amount of the regulated oxygen to be sent out of the "A" port to the Emergency oxygen Bypass Switch (EBS). When in the "OFF" position, the EBS sends this pressurized oxygen back into the "C" port on the IPR-2DL. The "C" port is connected to the upper plenum of the EVP, which allows the pressurized oxygen to hold the piston closed for normal operation. When the EBS is in the "ON" position, this pressurized oxygen is sent to the "B" port on the IPR-2DL, which is connected to the lower plenum of the EVP (the upper plenum is simultaneously vented to ambient). This opens the EVP and allows the regulated oxygen to exit the IPR-2DL through the "V2" emergency oxygen port. For both of the "V1" and "V2" ports, their respective valve pistons also double as indicators. When the "red button" on the top of the IPR-2DL is down/in, the valve is closed, and when the button is up/out, the valve is open. The regulated oxygen supply is also connected to a Low Pressure Relief Device (LPRD), which vents the regulated oxygen overboard in the case of an over-pressure scenario, until normal regulated pressure has been restored.

## Oxygen Distributor (Station Outlets) Description & Operation

The oxygen distributor units have a red 'push-to-test' button, a tricolor light behind the O<sub>2</sub> logo and an oxygen outlet connector. The button is mainly used as a test-for-readiness, but because it will also emit a 1-second blast of oxygen, it can be used as an 'I want O<sub>2</sub> now!' button for those who desire such. Each time the red button is pressed, the control head will display a ! in the corresponding station's status circle. The O<sub>2</sub> distributor unit will pass a 1-second blast of oxygen. However, if the button is pressed & held down, the O<sub>2</sub> distributor unit will pass oxygen only once. The button has to be released for at least 3 seconds before the station unit will respond with oxygen again.

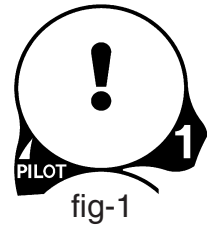

fig-1

The tricolor LED (fig-2) behind the O<sub>2</sub> logo on each O<sub>2</sub> distributor unit will light green for each positive inspiration response. It has been determined that the O<sub>2</sub> distributor unit should not emit light during nighttime operations unless there is a good reason. Therefore, the green light will not light from positive flow responses if the control head has detected a lights-on condition. Flow-faults will light the red LED and apnea conditions will light the yellow LED, in a much reduced brightness factor so that it would not be disruptive in a darkened cabin.



fig-2

The static port labeled 'DO NOT COVER' on each O<sub>2</sub> distributor unit must be vented directly and without any obstruction into the cabin. The rest of the unit is pneumatically insulated so that you have the freedom to install it into various situations, including vent ducts. It is very important that the front of the station with the static port not have any air blow directly into or across it. The oxygen outlet connector on each station is a standard one-touch fitting (see illustration on page 18). Stations not in use will emit a blast of oxygen once for each time the system is first turned on. It will not pass O<sub>2</sub> at any other time unless a cannula or face mask is connected and a person is breathing.

### **NOTE:**

*If no one is using a station when the system is first turned on, it will default to an active mode and display apnea once an active pressure altitude is detected. This can be cleared by pressing and releasing the **CLR/OFF** button.*

*The green LEDs on each station oxygen distributor unit will not light while the panel lights are on. This is necessary to keep the distributor units from acting as an annoyance during night operations. The red and amber LED will light if triggered, however, at a much lower level. All LEDs will resume to their normal mode and brightness while aircraft panel lights are off.*

### Description of DE-09 connector pins on the OXYGEN DISTRIBUTOR units:

- 01: Shield / Ground. Connected to enclosure of DIST unit.
- 02: System ground return for power & communications.
- 03: +10 VDC input supply with respect to ground.
- 04: Data from control head
- 05: Data to control head
- 06, 07, 08, 09: Diagnostic connections. DO NOT USE THESE!

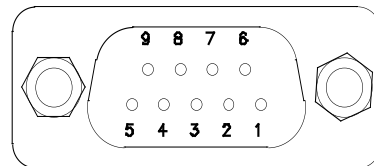

### IP Oxygen Distributor Unit

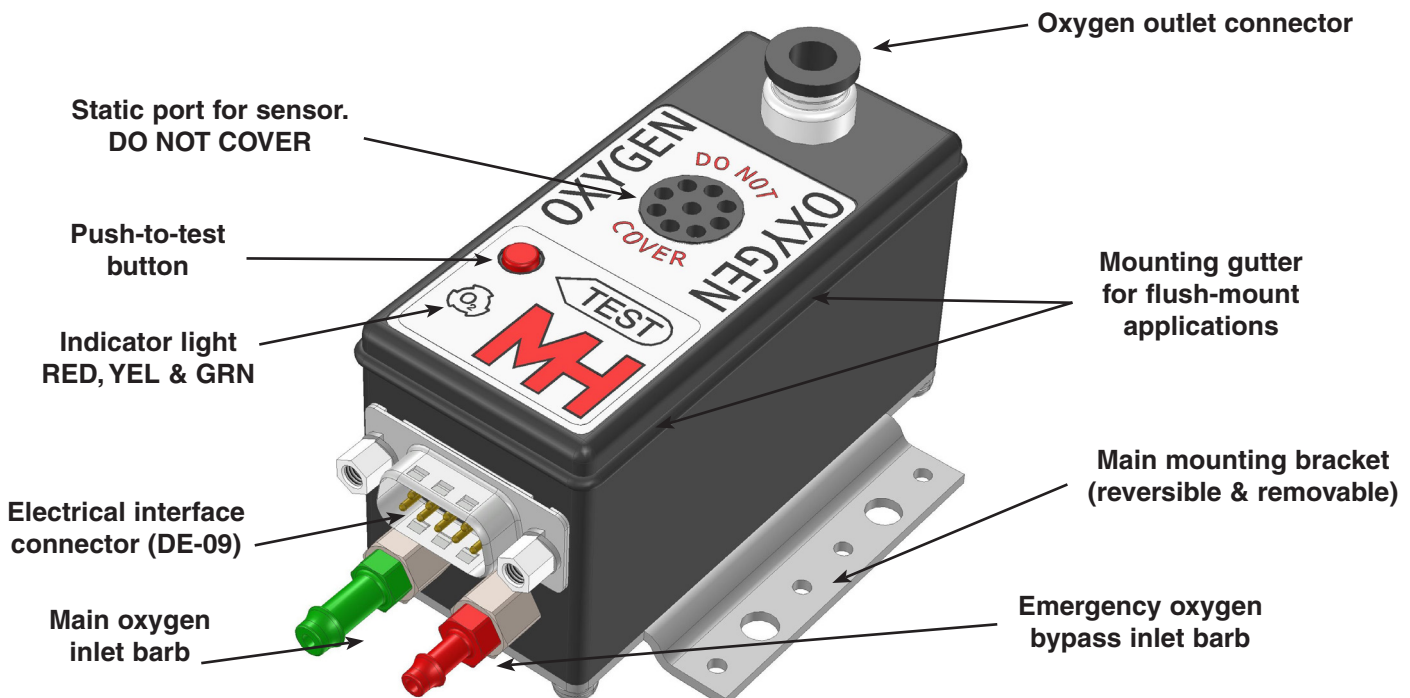



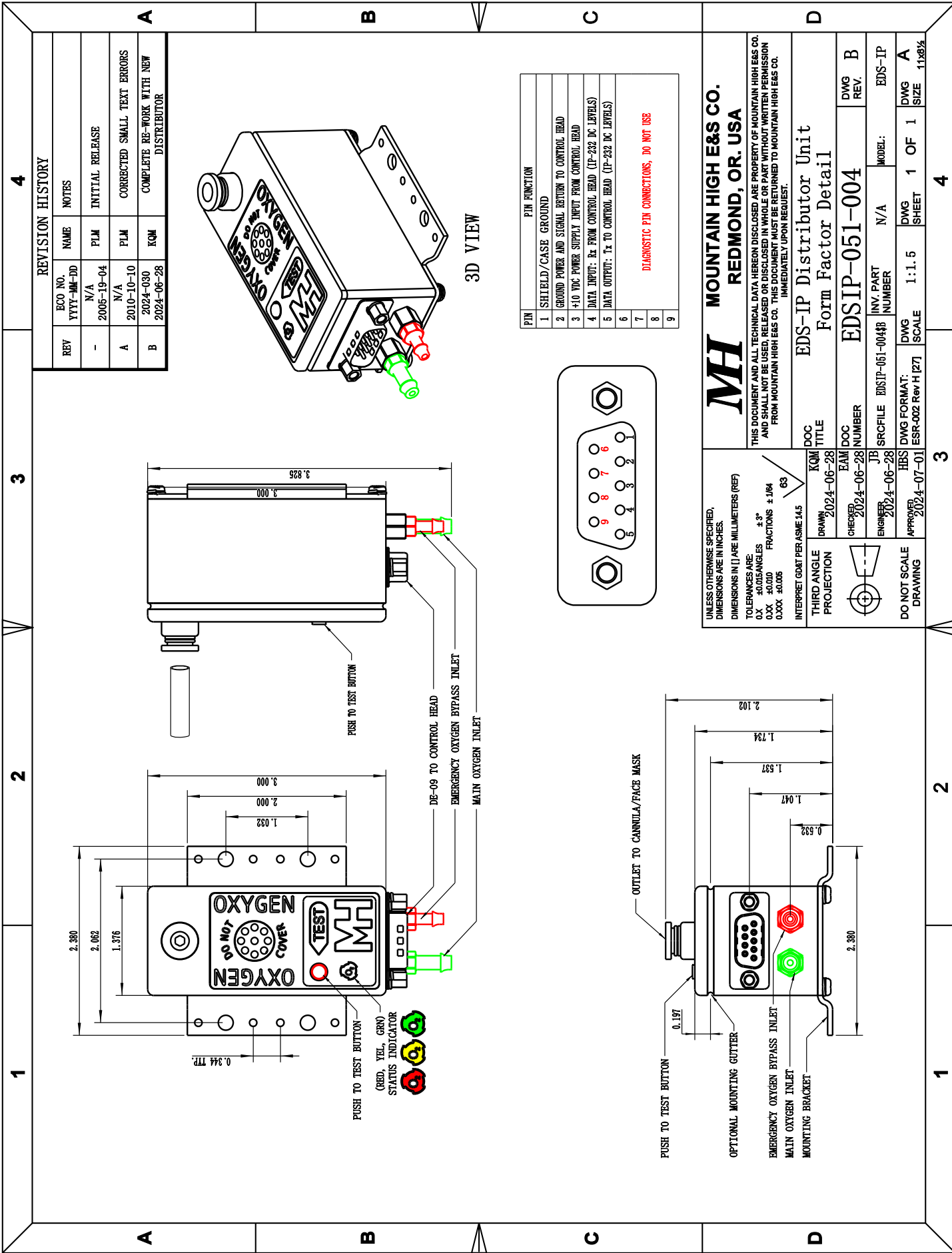

**REVISION HISTORY**

REV	ECO NO.	NAME	NOTES
-	2005-19-04	PLM	INITIAL RELEASE
A	2010-10-10	PLM	CORRECTED SMALL TEXT ERRORS
B	2024-06-28	KQM	COMPLETE RE-WORK WITH NEW DISTRIBUTOR

**PIN FUNCTION**

PIN	PIN FUNCTION
1	SHIELD/CASE GROUND
2	GROUND POWER AND SIGNAL RETURN TO CONTROL HEAD
3	+10 VDC POWER SUPPLY INPUT FROM CONTROL HEAD
4	DATA INPUT: Rx FROM CONTROL HEAD (IP-232 DC LEVELS)
5	DATA OUTPUT: Tx TO CONTROL HEAD (IP-232 DC LEVELS)
6	
7	
8	
9	

**DIAGNOSTIC PIN CONNECTIONS, DO NOT USE**

**MH MOUNTAIN HIGH E&S CO. REDMOND, OR. USA**

THIS DOCUMENT AND ALL TECHNICAL DATA HEREON DISCLOSED ARE PROPERTY OF MOUNTAIN HIGH E&S CO. AND SHALL NOT BE USED, REPRODUCED, COPIED, OR DISCLOSED IN WHOLE OR PART WITHOUT WRITTEN PERMISSION FROM MOUNTAIN HIGH E&S CO. THIS DOCUMENT MUST BE RETURNED TO MOUNTAIN HIGH E&S CO. IMMEDIATELY UPON REQUEST.

**EDS-IP Distributor Unit Form Factor Detail**

DOC TITLE: EDS-IP Distributor Unit  
 DRAWN: KQM  
 CHECKED: EAM  
 ENGINEER: JB  
 APPROVED: HBS

DATE: 2024-06-28  
 DATE: 2024-06-28  
 DATE: 2024-06-28  
 DATE: 2024-07-01

SCALE: 1:1.5  
 SHEET: 1 OF 1  
 SIZE: 11x8 1/2

DWG REV: B  
 MODEL: EDS-IP

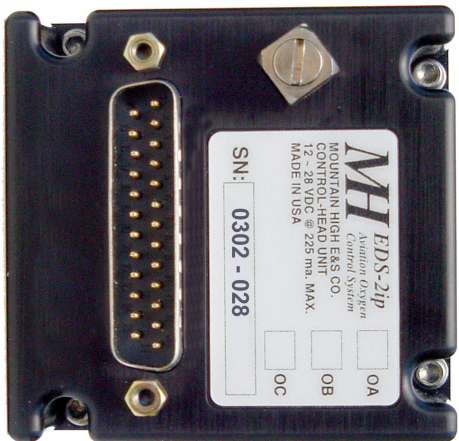
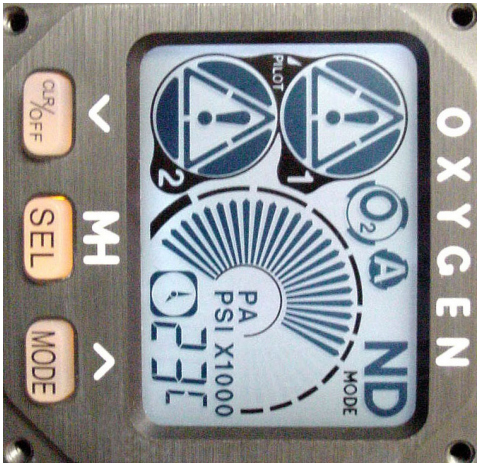
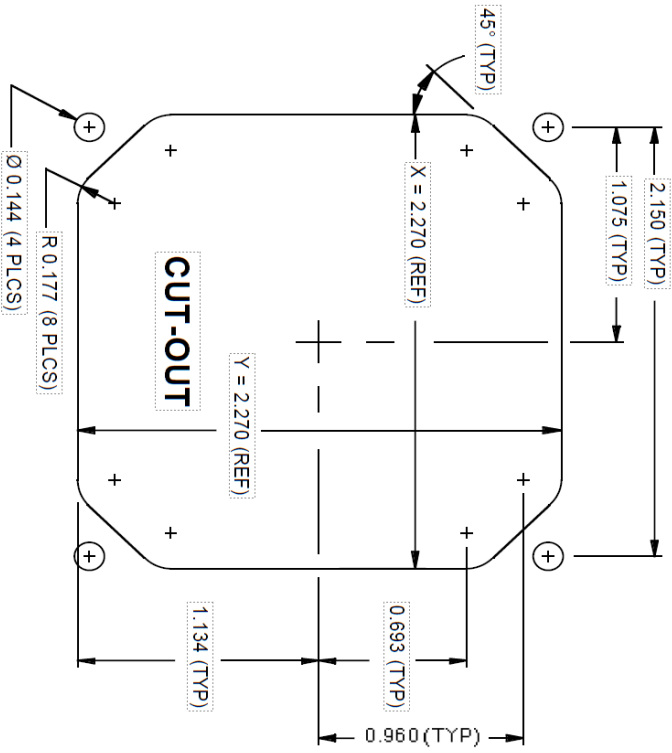
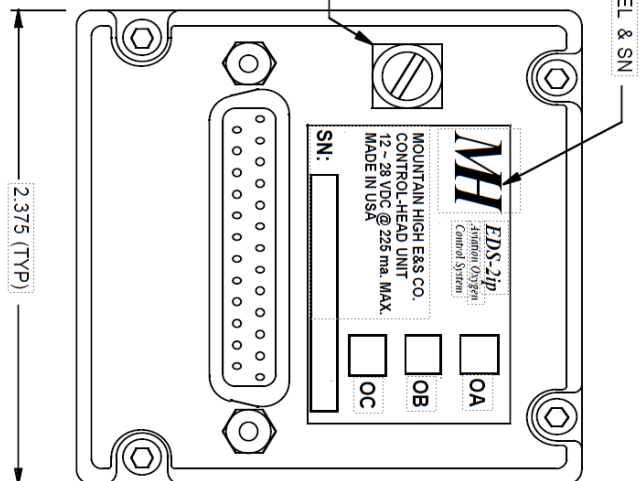
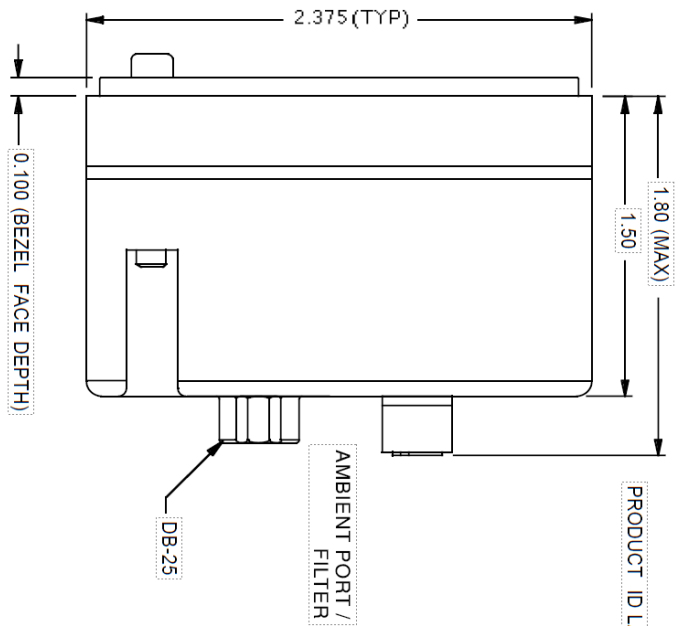
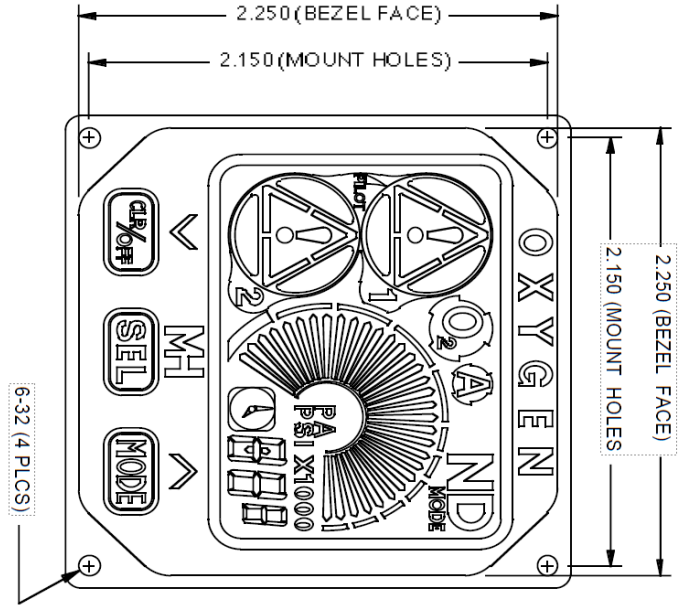

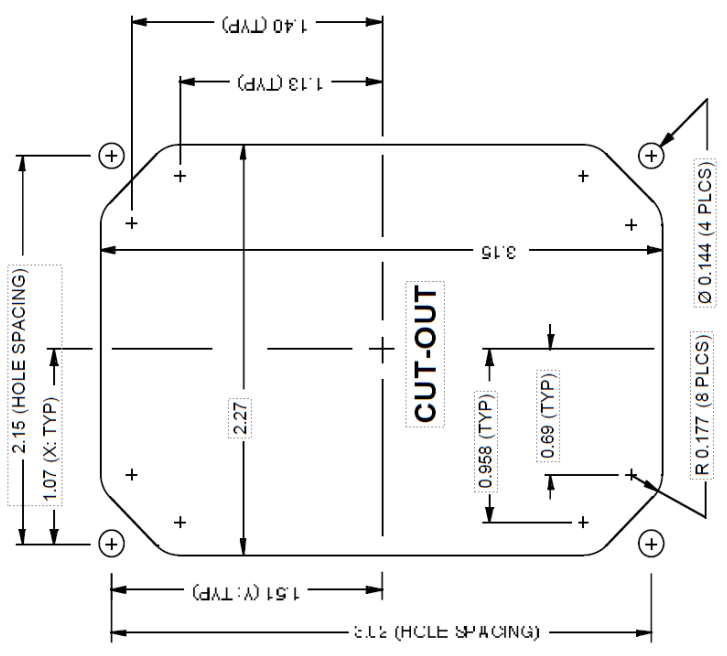
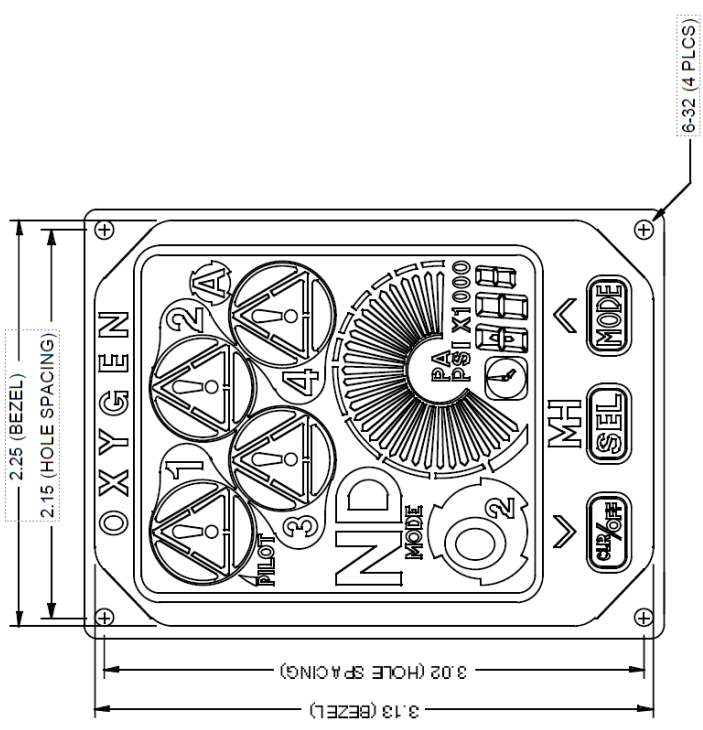
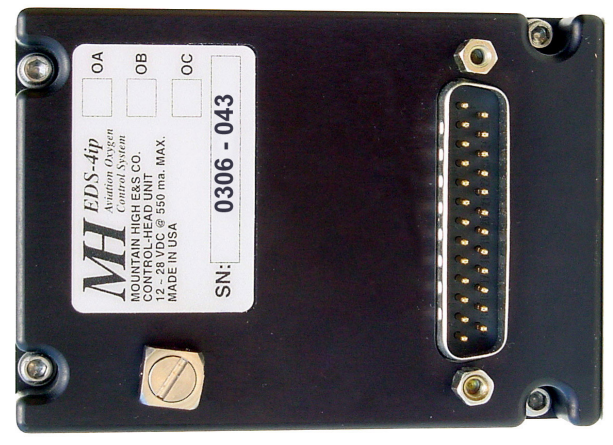
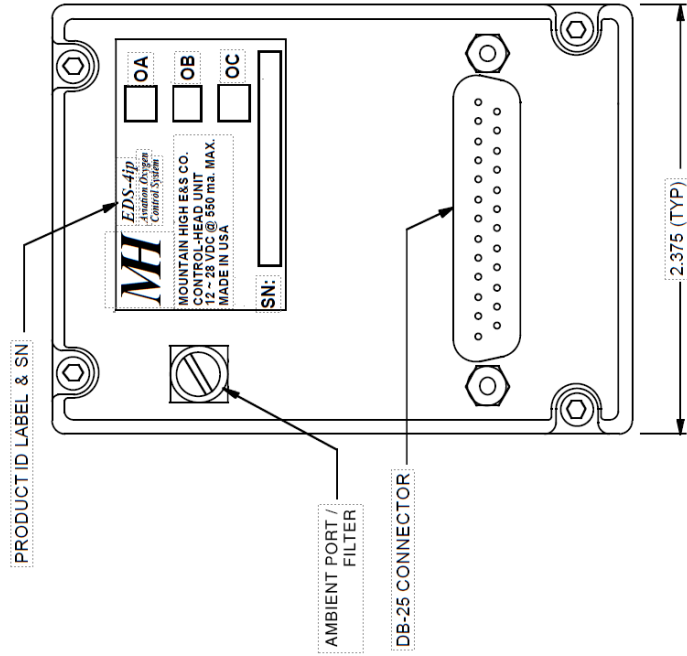
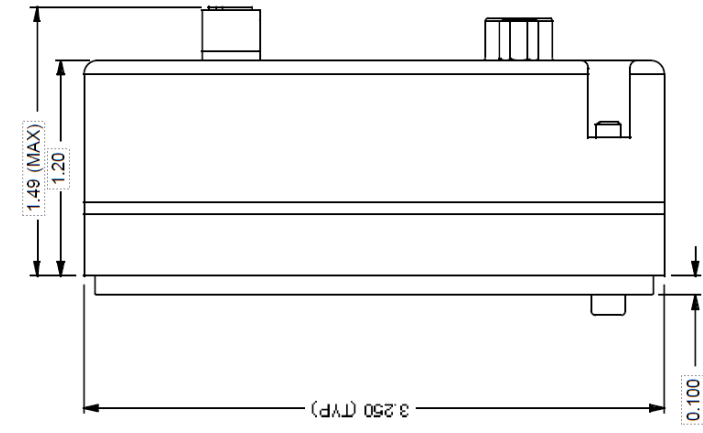

## Basic IPR Components & Suggested Installation Layouts

Shown here is a typical installation method with polyurethane lines suitable for experimental-built high-performance aircraft.

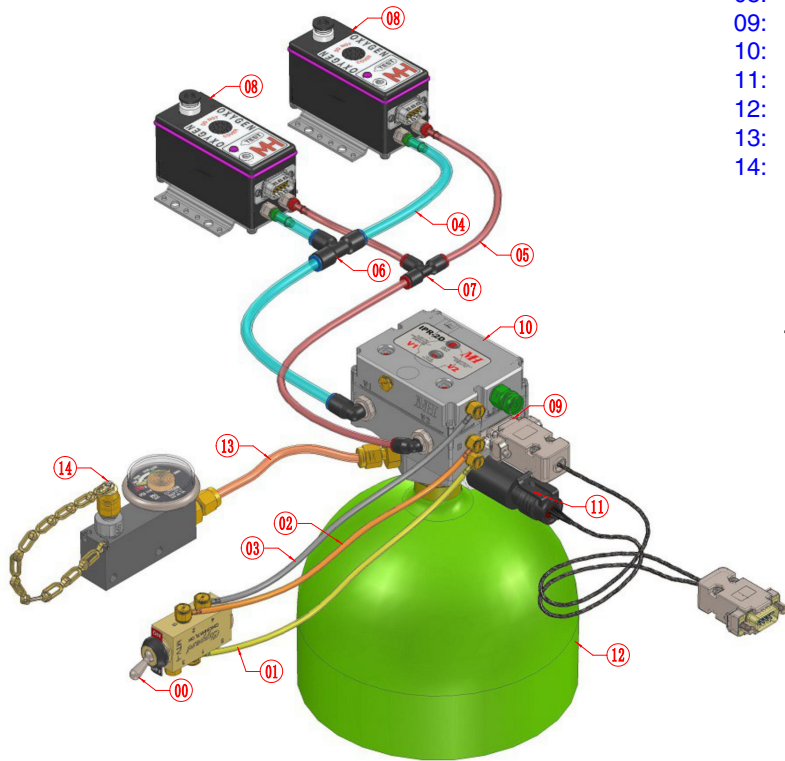

- 00: Emergency Oxygen Bypass Switch
- 01: Emergency bypass pressure feed. Yellow (Port A)
- 02: Emergency bypass pressure open. Orange (Port B)
- 03: Emergency bypass pressure close. Grey (Port C)
- 04: Main O<sub>2</sub> polyurethane tubing 6 mm. OD
- 05: Emergency O<sub>2</sub> polyurethane tubing 4 mm. OD
- 06: 'Tee' union for 6 mm polyurethane tubing
- 07: 'Tee' union for 4 mm polyurethane tubing
- 08: Electronic oxygen delivery unit 'Distributor'
- 09: Connector to IP control head (DE-09)
- 10: IPR regulator assy.
- 11: Electronic pressure sending unit (4-20 ma. type)
- 12: Oxygen tank / cylinder
- 13: 1/8" OD HP copper line to fill-station assy.
- 14: Oxygen fill-station assy. (others available by option)

### How to Use One-touch Fittings

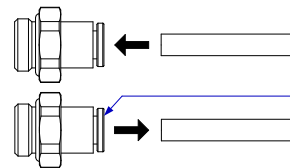

**INSERTING**  
Push in the tubing

**REMOVING**  
1. Push in the connector collar  
2. Pull the tube straight back while holding the collar in

**To INSERT TUBING:** Push the tubing into the connector until resistance is felt, then push a little further, about 1/8 inch [3 mm]. Gently tug on the tubing to make sure it is captured.

**To REMOVE TUBING:** Push the tubing in slightly, then push in the connector collar while pulling gently on the tubing.

When removing tubing, **DO NOT pull on the tubing without pushing in the collar**, as this will likely damage the connector.

**To ensure the proper flow of oxygen while the cylinders become low (~800 psig and below) it is very important that 3/16" diameter tube be used between the IPR regulator and cylinder if it is to be remotely mounted. This applies to remotely coupling cylinders as well. The fill station can be plumbed with 1/8" OD tubing.**

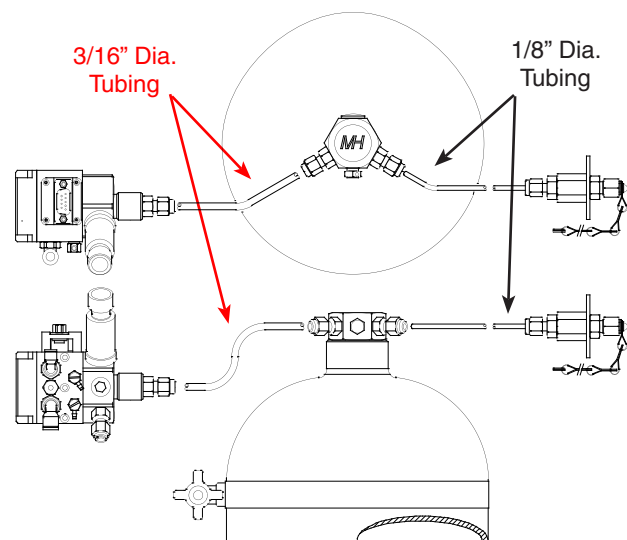
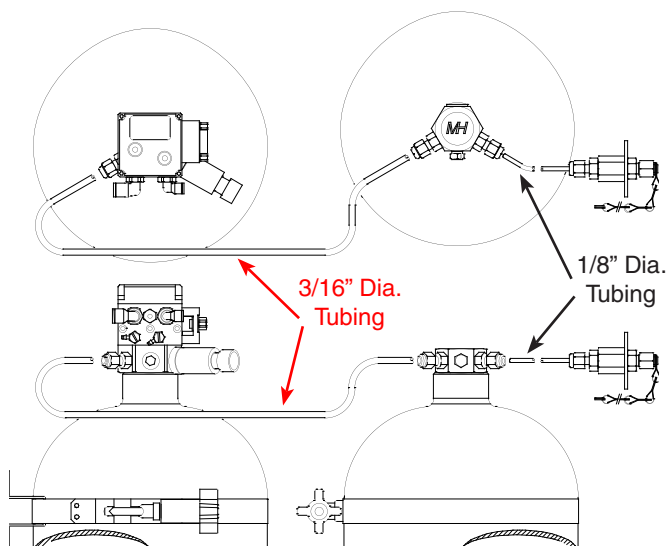

# Basic IPR Components & Suggested Installation Layouts

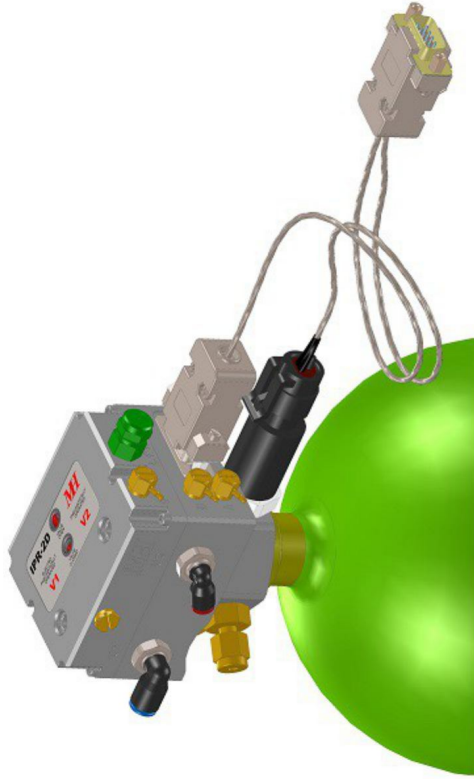

- 01 Main O<sub>2</sub> outlet swivel-elbow fitting (6mm)
- 02 EMERGENCY O<sub>2</sub> bypass outlet swivel-elbow fitting (4mm)
- 03 EMERGENCY O<sub>2</sub> bypass pressure feed. "A" 1 BAR (15 PSIG) (YELLOW)
- 04 EMERGENCY bypass pressure open. "B" 1 BAR (15 PSIG) (ORANGE)
- 05 EMERGENCY bypass pressure closed. "C" 1 BAR (15 PSIG) (GREY)
- 06 HP SAE-4 to 1/8" OD tube fitting for fill station
- 07 Electronic pressure sending unit (4-20ma.)
- 08 Electrical interface connector DE-09M
- 09 Low pressure relief device (LPRD)
- 10 High pressure relief device (HPRD) w/ SAE-4 Adapter
- V1 Main oxygen valve pop-up indicator
- V2 EMERGENCY oxygen bypass valve pop-up indicator

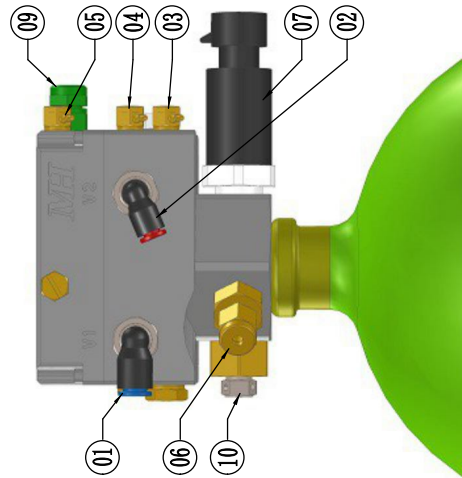
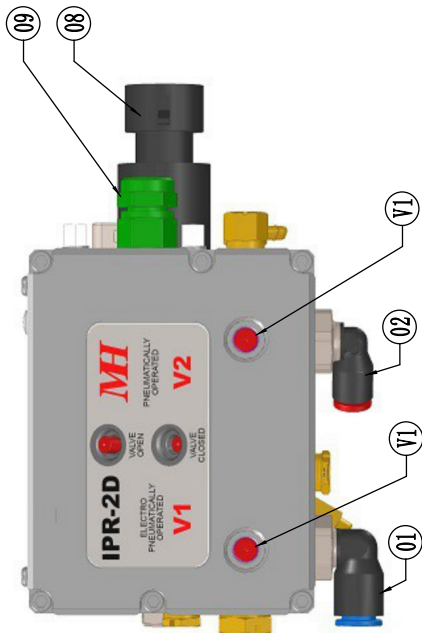
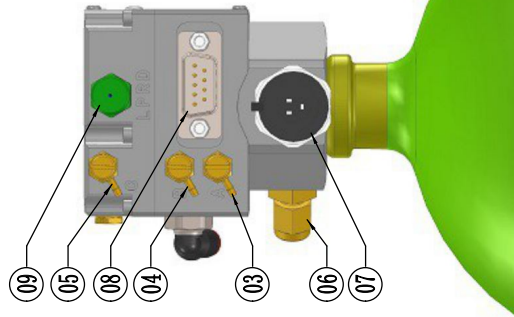

OXYGEN DISTRIBUTOR CONTROL AND DISPLAY HEAD

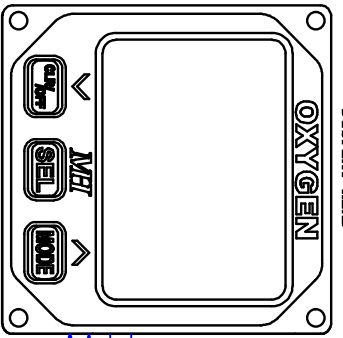

REF	DESCRIPTION
1	DR-26 CONNECTOR AND CABLES (WITH GROUNDED SHIELD)
2	ACFT PWR/GND, INSTRUMENT LIGHTS, AUDIO ALARM
3	CONTROL HEAD TO DISTRIBUTOR CONNECTION
4	CONTROL HEAD TO IPR (OR RCV/RCR) CONNECTION
5	REGULATED MAIN OXYGEN, 1 BAR
6	REGULATED EMERGENCY OXYGEN, 1 BAR
7	DELUGE FILL STATION & HP LINE
8	EMERGENCY OXYGEN BYPASS PRESSURE FEED LINE
9	EMERGENCY OXYGEN BYPASS OPEN LINE
10	EMERGENCY OXYGEN BYPASS CLOSED LINE
11	OXYGEN DISTRIBUTOR OUTLET STATION -1
12	OXYGEN DISTRIBUTOR OUTLET STATION -2
13	EMERGENCY OXYGEN BYPASS SWITCH
14	DISTRIBUTOR OXYGEN INLET
15	DISTRIBUTOR EMERGENCY OXYGEN INLET
16	OXYGEN TANK
17	OXYGEN DISTRIBUTOR DE-09 CONNECTOR
18	IPR-2D REGULATOR

NOTES

1

2

3

4

REVISION HISTORY			
REV	ECO NO.	NAME	NOTES
001	2024-TED	KQM	INITIAL RELEASE

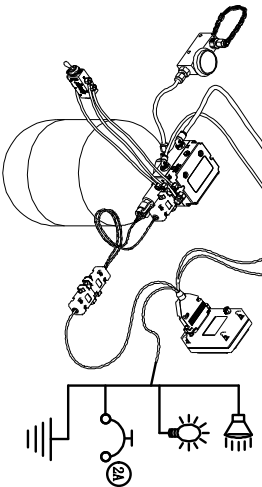
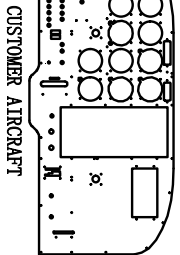
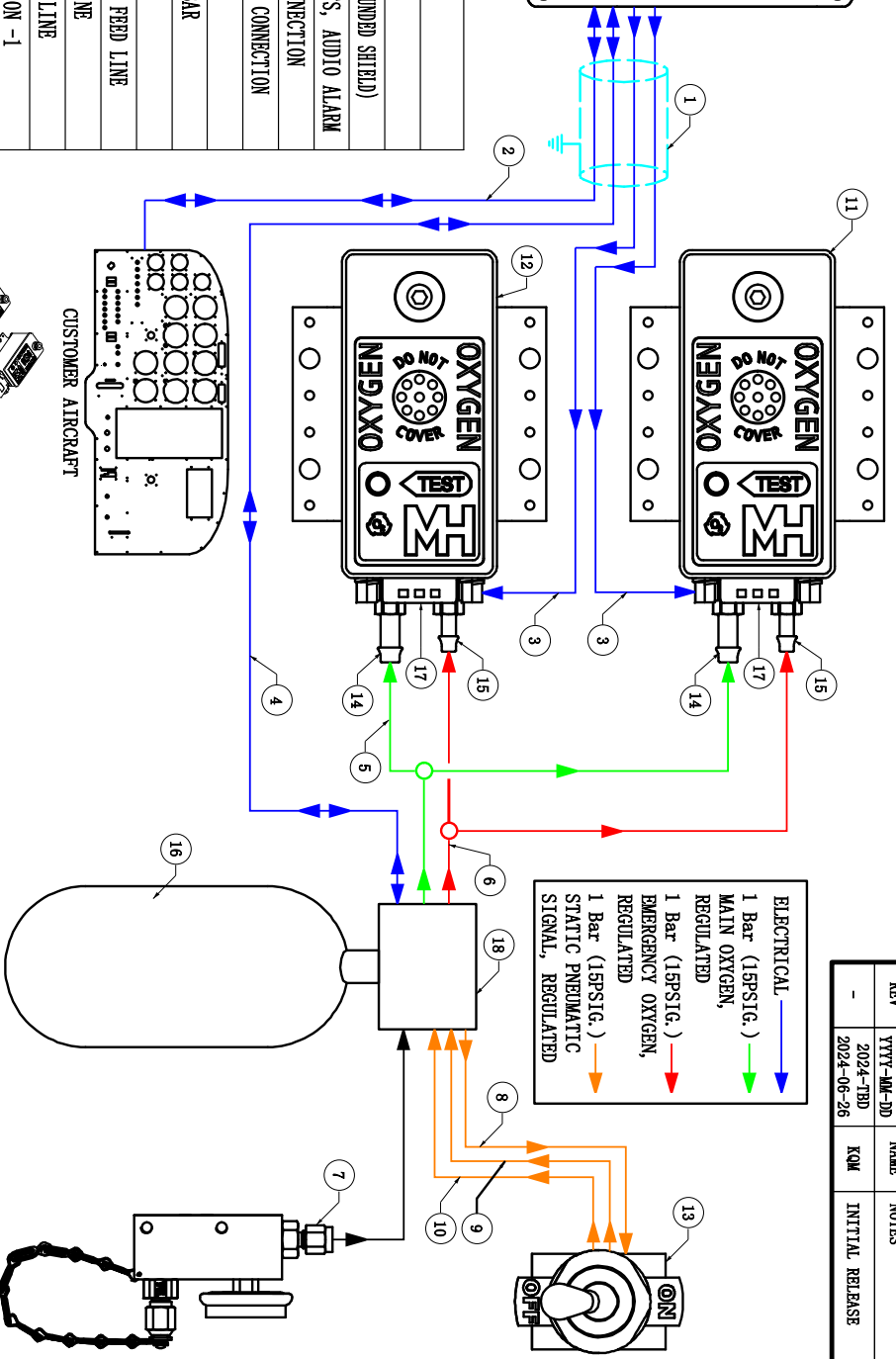
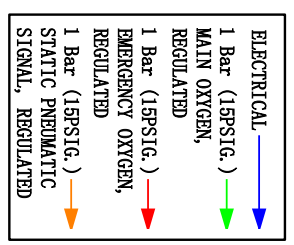

**MOUNTAIN HIGH E&S CO.**  
REDMOND, OR, USA

THIS DOCUMENT AND ALL TECHNICAL DATA HEREON DISCLOSED ARE PROPERTY OF MOUNTAIN HIGH E&S CO. AND SHALL NOT BE USED, RELEASED OR DISCLOSED IN WHOLE OR PART WITHOUT WRITTEN PERMISSION FROM MOUNTAIN HIGH E&S CO. THIS DOCUMENT MUST BE RETURNED TO MOUNTAIN HIGH E&S CO. IMMEDIATELY UPON REQUEST.

THIRD ANGLE PROJECTION	DO NOT SCALE DRAWING	EDSIP-151-000	
DO NOT SCALE DRAWING		DOC NUMBER	REV. -
DRAWN	EAM	DOC	REV.
2024-06-26	2024-07-01	EDSIP-151-000	-
CHECKED	PLM	SRCFILE	MODEL:
2024-07-01	2024-07-01	EDSIP-151-000	IPR-2D
ENGINEER	HBS	DWG FORMAT	DWG NUMBER
2024-07-01	2024-07-01	ESR-002 Rev H (271)	IPR-2D
APPROVED	DMG	SCALE	NTS
2024-07-01	2024-07-01	SCALE	1 OF 1
			SIZE 11x8 1/2

1

2

3

4

4

REVISION HISTORY			
REV	ECO NO.	NAME	NOTES
-	2024-TED	KQM	INITIAL RELEASE

3

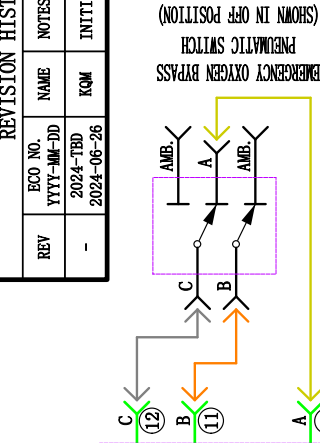

2

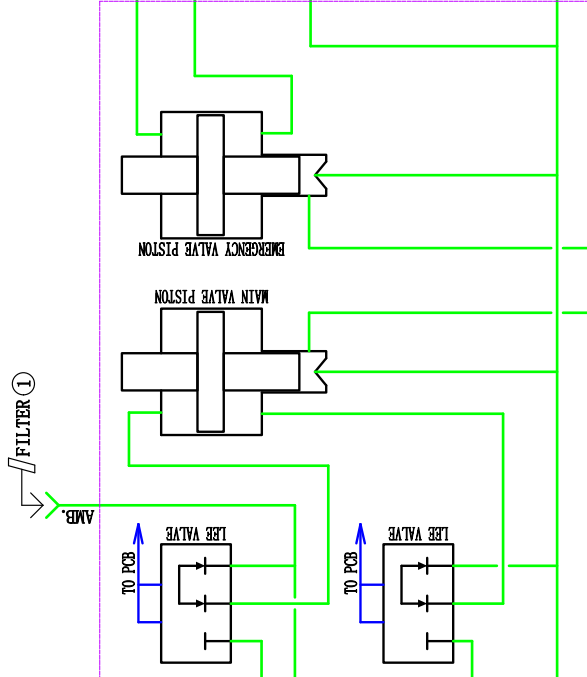

1

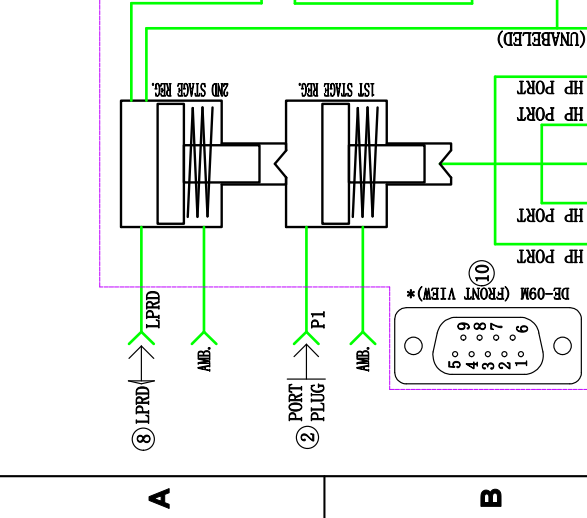

B

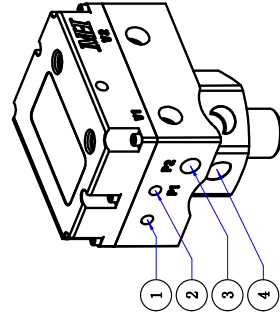

C

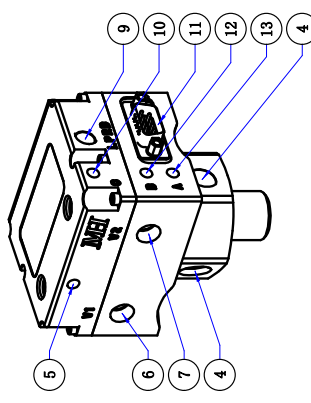

D

IPR-2D PORTS & CONNECTIONS		HIGH PRESSURE PORT OPTIONS	
REF	DESCRIPTION	FITTING	PORT
1	UNLABELED AMBIENT PORT (FILTER)	PRESSURE TRANSDUCER	
2	"P1" PORT (PORT PLUG)	FILL STATION	ANY
3	"P2" PORT (PORT PLUG)	HPD AND SAE-4 PORT ADAPTER	
4	HIGH PRESSURE PORT (SEE HP PORT OPTIONS)	PORT PLUG OR OR CUSTOMER SPECIFIED PERIPHERAL	
5	UNLABELED MACHINING PORT (PORT PLUG)		
6	"V1" PORT (6mm ONE-TOUCH ELBOW FITTING)		

IPR-2D PORTS & CONNECTIONS		HIGH PRESSURE PORT OPTIONS	
REF	DESCRIPTION	FITTING	PORT
7	"V2" PORT (4mm ONE-TOUCH ELBOW FITTING)	PRESSURE TRANSDUCER	
8	"LPRD" PORT (LPRD)	FILL STATION	ANY
9	"A" PORT (BANJO FITTING, ORIFICE)	HPD AND SAE-4 PORT ADAPTER	
10	DE-09 CONNECTOR	PORT PLUG OR OR CUSTOMER SPECIFIED PERIPHERAL	
11	"B" PORT (BANJO FITTING)		
12	"C" PORT (BANJO FITTING)		

**MH MOUNTAIN HIGH E&S CO. REDMOND, OR. USA**

THIS DOCUMENT AND ALL TECHNICAL DATA HEREON DISCLOSED ARE PROPERTY OF MOUNTAIN HIGH E&S CO. AND SHALL NOT BE USED, RELEASED OR DISCLOSED IN WHOLE OR PART WITHOUT WRITTEN PERMISSION FROM MOUNTAIN HIGH E&S CO. THIS DOCUMENT MUST BE RETURNED TO MOUNTAIN HIGH E&S CO. IMMEDIATELY UPON REQUEST.

DO NOT SCALE DRAWING

THIRD ANGLE PROJECTION

DOC TITLE: IPR-2D INTERNAL SCHEMATIC

DOC NUMBER: EDSIP-051-007

DOC DATE: 2024-06-26

ENGINEER: EDSIP-051-007-01

CHECKED: 2024-07-01

DRAWN: 2024-06-26

APPROVED: 2024-07-01

HBS DWG FORMAT: ESR-002 Rev H [27]

SCALE: NTS

MODEL: N/A

INVT. PART NUMBER: EDSIP-051-007-01

DWG REV.:

DWG SHEET: 1 OF 1

SIZE: 11x8 1/2

REVISION HISTORY			
REV	REV. NO.	NAME	NOTES
-	2024-019	KJM	INITIAL RELEASE
-	2025-019-01		

**NOTICE 1**  
 IPR TO CONTROL HEAD ELECTRICAL INTERCONNECT PIN-OUT HAS CHANGED FROM THE IPR-1 TO IPR-2. USE REVISED PIN-OUT

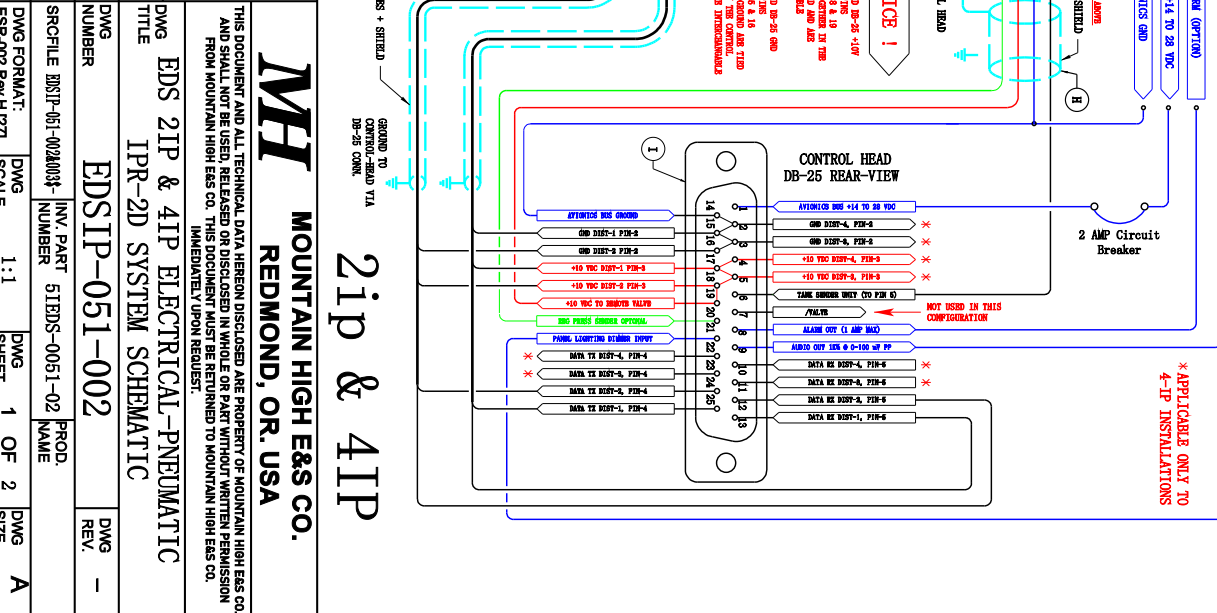
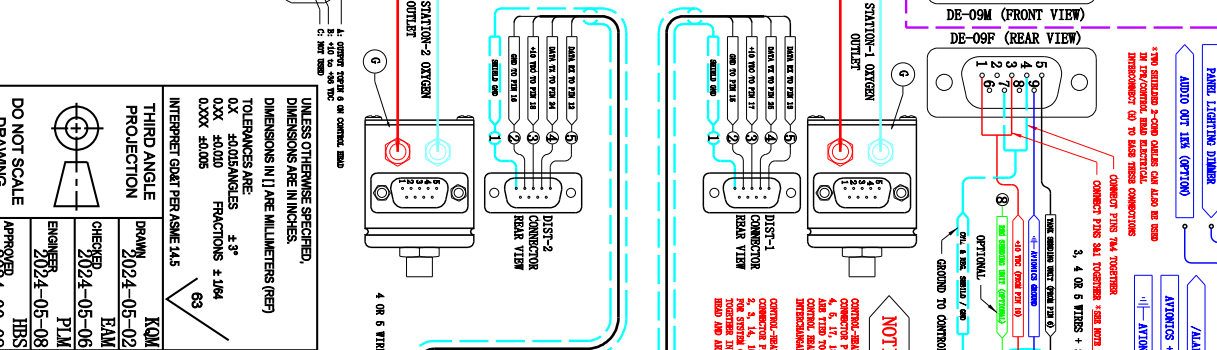
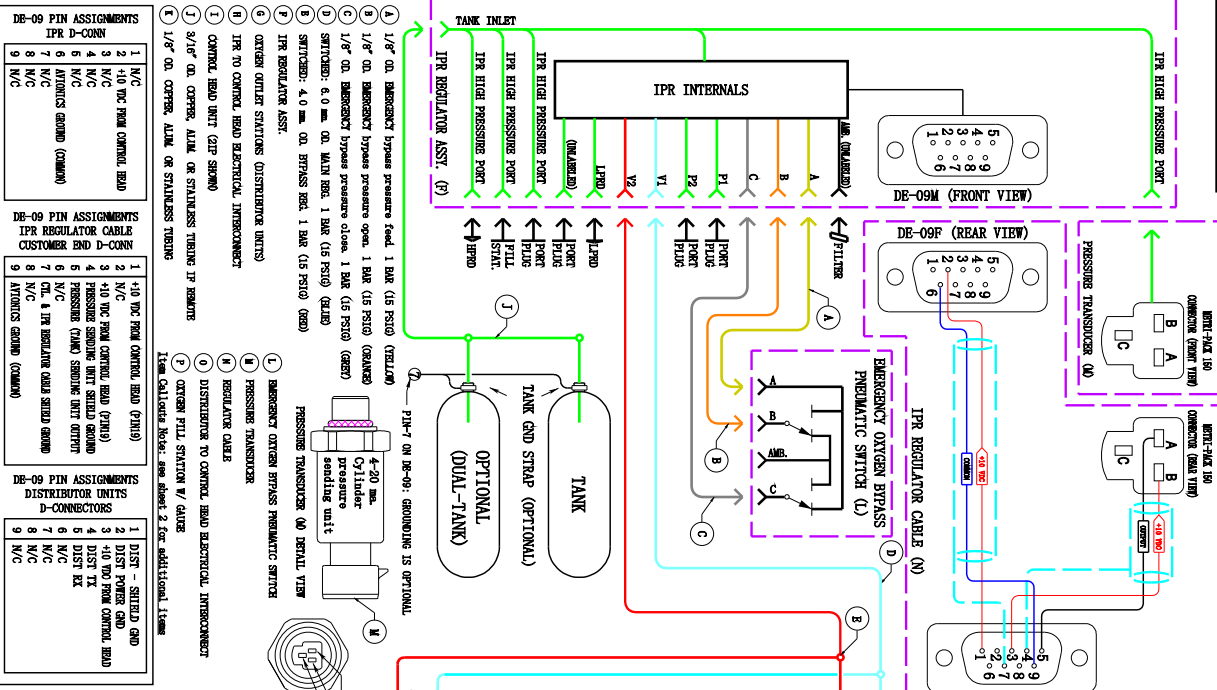

REV	REV. NO.	NAME	NOTES
-	2024-019	KJM	INITIAL RELEASE
-	2025-019-01		

1	1/8" O.D. EMERGENCY bypass pressure feed, 1 BAR (15 PSIG) (YELLOW)
2	1/8" O.D. EMERGENCY bypass pressure open, 1 BAR (15 PSIG) (GREEN)
3	1/8" O.D. EMERGENCY bypass pressure close, 1 BAR (15 PSIG) (RED)
4	SWITCHED: 6.0 mm. O.D. MAIN REG. 1 BAR (15 PSIG) (GREEN)
5	SWITCHED: 4.0 mm. O.D. PRESS. REL. 1 BAR (15 PSIG) (RED)
6	REGULATOR ASS'T
7	OPTIONAL OUTLET STATIONS (OXYGEN/ NITROGEN)
8	IPR TO CONTROL HEAD ELECTRICAL INTERCONNECT
9	CONTROL HEAD UNIT (ZIP SCHEM)
10	3/16" O.D. COPPER, ALUM. OR STAINLESS TUBING IPR REGULATOR
11	1/8" O.D. COPPER, ALUM. OR STAINLESS TUBING

1	+10 TRC FROM CONTROL HEAD (7919)
2	N/C
3	N/C
4	N/C
5	N/C
6	N/C
7	N/C
8	N/C
9	N/C

1	DIST - SHIELD GND
2	DIST - FROM CONTROL HEAD
3	DIST - FROM CONTROL HEAD
4	DIST TX
5	N/C
6	N/C
7	N/C
8	N/C
9	N/C

UNLESS OTHERWISE SPECIFIED, DIMENSIONS ARE IN INCHES. DIMENSIONS IN PARENTHESISES (MM) ARE FOR INFORMATION ONLY.

TOLERANCES ARE: ±.03" UNLESS OTHERWISE SPECIFIED ±.004" UNLESS OTHERWISE SPECIFIED

INTERFERE GOOD PER ISM 14.5

THIRD ANGLE PROJECTION

**NOTICE 1**  
 CONTROL HEAD DB-25 PIN-OUT HAS CHANGED FROM THE IPR-1 TO IPR-2. USE REVISED PIN-OUT

CONTROL HEAD DB-25 PIN-OUT:  
 1. ATMICS +14 TO 28 TRC  
 2. ALARM OUT 13 AMP W/O  
 3. AUDIO OUT 12K (OPTION)  
 4. DATA RE DB25-4, PIN-5  
 5. DATA RE DB25-5, PIN-6  
 6. DATA RE DB25-6, PIN-7  
 7. DATA RE DB25-7, PIN-8  
 8. DATA RE DB25-8, PIN-9  
 9. DATA RE DB25-9, PIN-10  
 10. DATA RE DB25-10, PIN-11  
 11. DATA RE DB25-11, PIN-12  
 12. DATA RE DB25-12, PIN-13  
 13. DATA RE DB25-13, PIN-14  
 14. DATA RE DB25-14, PIN-15  
 15. DATA RE DB25-15, PIN-16  
 16. DATA RE DB25-16, PIN-17  
 17. DATA RE DB25-17, PIN-18  
 18. DATA RE DB25-18, PIN-19  
 19. DATA RE DB25-19, PIN-20  
 20. DATA RE DB25-20, PIN-21  
 21. DATA RE DB25-21, PIN-22  
 22. DATA RE DB25-22, PIN-23  
 23. DATA RE DB25-23, PIN-24  
 24. DATA RE DB25-24, PIN-25

ALL WIRING 22 - 24 AWG.  
 Audio output is microphone compatible

\* APPLICABLE ONLY TO 4-IP INSTALLATIONS

**2IP & 4IP**  
 MOUNTAIN HIGH E&S CO.  
 REDMOND, OR, USA

1 2 3 4

DWG TITLE: EDS 2IP & 4IP ELECTRICAL-PNEUMATIC IPR-2D SYSTEM SCHEMATIC

DWG NO.: EDSIP-051-002

DATE: 2024-05-02

DESIGNED BY: PJM

CHECKED BY: ESR

APPROVED BY: HBS

DWG SCALE: 1:1

DWG SHEET: 1 OF 2

DWG SIZE: 11x8 1/2



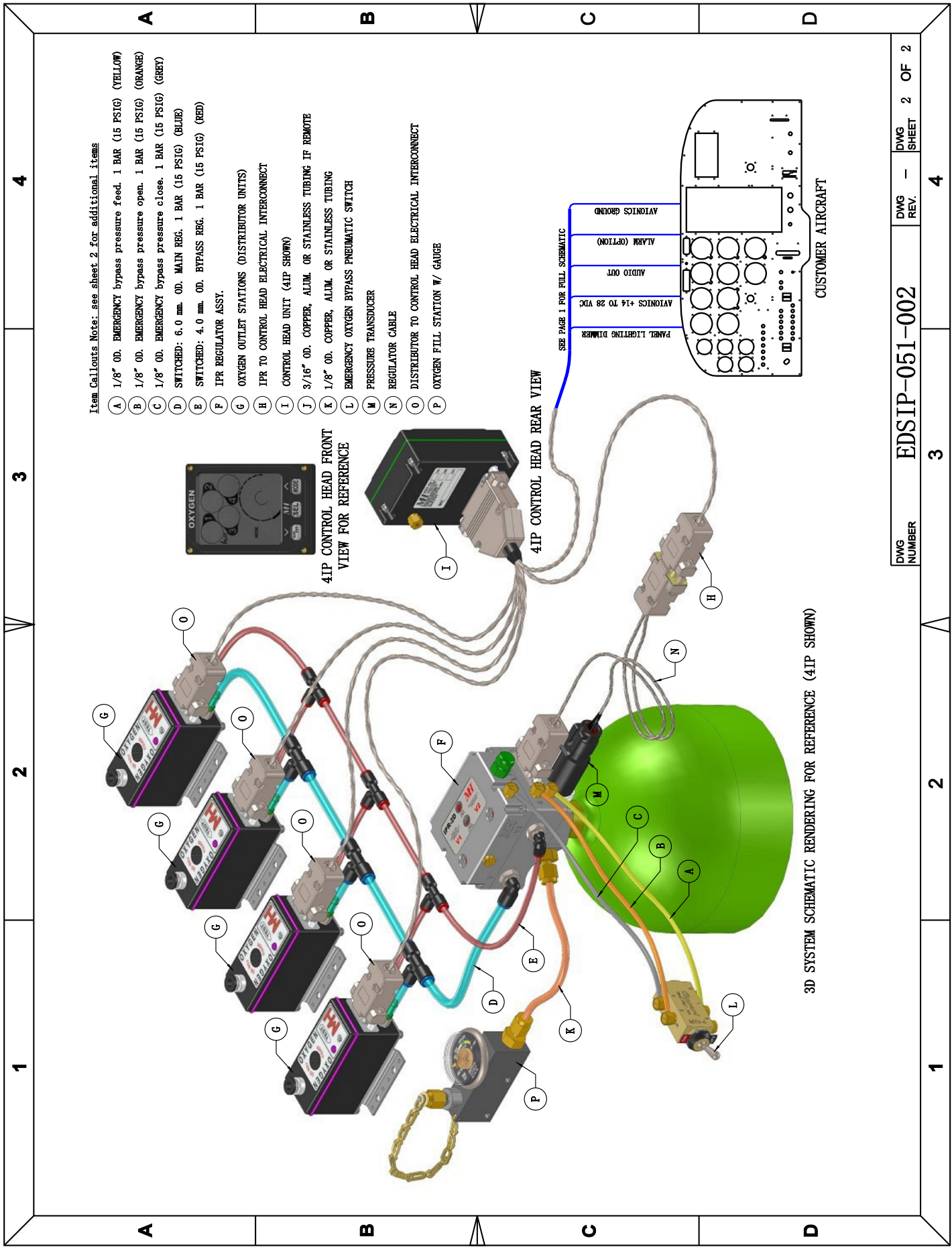

Item Callouts Note: see sheet 2 for additional items

- A 1/8" OD. EMERGENCY bypass pressure feed. 1 BAR (15 PSIG) (YELLOW)
- B 1/8" OD. EMERGENCY bypass pressure open. 1 BAR (15 PSIG) (ORANGE)
- C 1/8" OD. EMERGENCY bypass pressure close. 1 BAR (15 PSIG) (GREY)
- D SWITCHED: 6.0 mm. OD. MAIN REG. 1 BAR (15 PSIG) (BLUE)
- E SWITCHED: 4.0 mm. OD. BYPASS REG. 1 BAR (15 PSIG) (RED)
- F IPR REGULATOR ASSY.
- G OXYGEN OUTLET STATIONS (DISTRIBUTOR UNITS)
- H IPR TO CONTROL HEAD ELECTRICAL INTERCONNECT
- I CONTROL HEAD UNIT (4IP SHOWN)
- J 3/16" OD. COPPER, ALUM. OR STAINLESS TUBING IP REMOTE
- K 1/8" OD. COPPER, ALUM. OR STAINLESS TUBING
- L EMERGENCY OXYGEN BYPASS PNEUMATIC SWITCH
- M PRESSURE TRANSDUCER
- N REGULATOR CABLE
- O DISTRIBUTOR TO CONTROL HEAD ELECTRICAL INTERCONNECT
- P OXYGEN FILL STATION W/ GAUGE

4IP CONTROL HEAD FRONT VIEW FOR REFERENCE

4IP CONTROL HEAD REAR VIEW

3D SYSTEM SCHEMATIC RENDERING FOR REFERENCE (4IP SHOWN)

# Zip & 4ip control head DB-25 Electrical Connection Legend FOR USE WITH IPR

CONTROL-HEAD DB-25  
GND CONNECTOR PINS  
2, 3, 14, 15 & 16  
FOR SYSTEM GROUND  
ARE TIED TOGETHER IN  
THE CONTROL HEAD AND  
ARE INTERCHANGABLE

CONTROL-HEAD DB-25  
+10V CONNECTOR PINS  
4, 5, 17, 18 & 19  
ARE TIED TOGETHER IN  
THE CONTROL HEAD AND  
ARE INTERCHANGABLE

**NOTICE !**

AVIONICS BUS  
+14 to +28 VDC

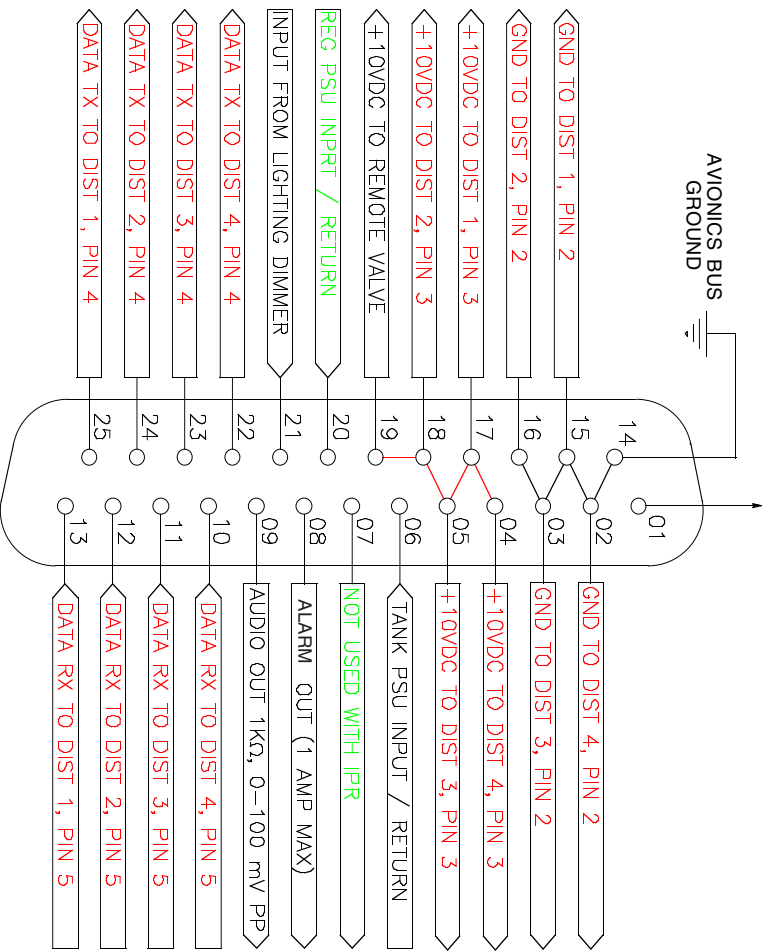

PIN	PIN FUNCTION
01	AVIONICS BUS +12 TO +28 VDC
02	GROUND TO DISTRIBUTOR 4, PIN 2 (4IP ONLY)
03	GROUND TO DISTRIBUTOR 3, PIN 2 (4IP ONLY)
04	+10 VDC TO DISTRIBUTOR 4, PIN 3 (4IP ONLY)
05	+10 VDC TO DISTRIBUTOR 3, PIN 3 (4IP ONLY)
06	INPUT / RETURN FROM TANK PRESSURE SENDING UNIT (PSU), PIN 5
07	NOT USED IF USING THE IPR REGULATOR
08	GROUND SUPPLY FOR ALARM (1 AMP MAX.)
09	AUDIO OUTPUT (1 KΩ @ 0 - 100 mv PP)
10	DATARX TO DISTRIBUTOR 4, PIN 5 (4IP ONLY)
11	DATARX TO DISTRIBUTOR 3, PIN 5 (4IP ONLY)
12	DATARX TO DISTRIBUTOR 2, PIN 5
13	DATARX TO DISTRIBUTOR 1, PIN 5
14	AVIONICS BUS GROUND
15	GROUND TO DISTRIBUTOR 1, PIN 2
16	GROUND TO DISTRIBUTOR 2, PIN 2
17	+10 VDC TO DISTRIBUTOR 2, PIN 3
18	+10 VDC TO DISTRIBUTOR 1, PIN 3
19	+10 VDC SUPPLY TO REMOTE VALVE SOLENOID COIL / VALVE, PINS 2 & 9
20	INPUT FROM REGULATOR PRESSURE GAUGE (OPTIONAL ITEM)
21	INPUT FROM PANEL LIGHTING DIMMER
22	DATATX TO DISTRIBUTOR 4, PIN 4 (4IP ONLY)
23	DATATX TO DISTRIBUTOR 3, PIN 4 (4IP ONLY)
24	DATATX TO DISTRIBUTOR 2, PIN 4
25	DATATX TO DISTRIBUTOR 1, PIN 4

REVISION HISTORY		NOTES	
REV	DATE	BY	DESCRIPTION
A	06-05-05	PLM	REVISED NOMENCLATURE
B	05-03-06	PLM	CORRECTED NAMES
C	14-11-08	PLM	CORRECTED AUDIO OUTPUT SPECS

Audio output is microphone compatible

THIRD ANGLE PROJECTION

[KC] NUMBER OF KEY CHARACTERISTICS IN THIS DRAWING / DOCUMENT PER NH DOC. ESR-001

**MH** MOUNTAIN HIGH E&S CO. REDMOND, OR, USA

ISSUED:	DATE	EDS-IP CONNECTOR ASSIGNMENT
DRAWN:	DATE	REV C
ENGINEER:	DATE	
APPR:	DATE	

DWG. #: EDSIP-051-003

SIZE: A SHEET 1 OF 1

DO NOT SCALE DRAWING

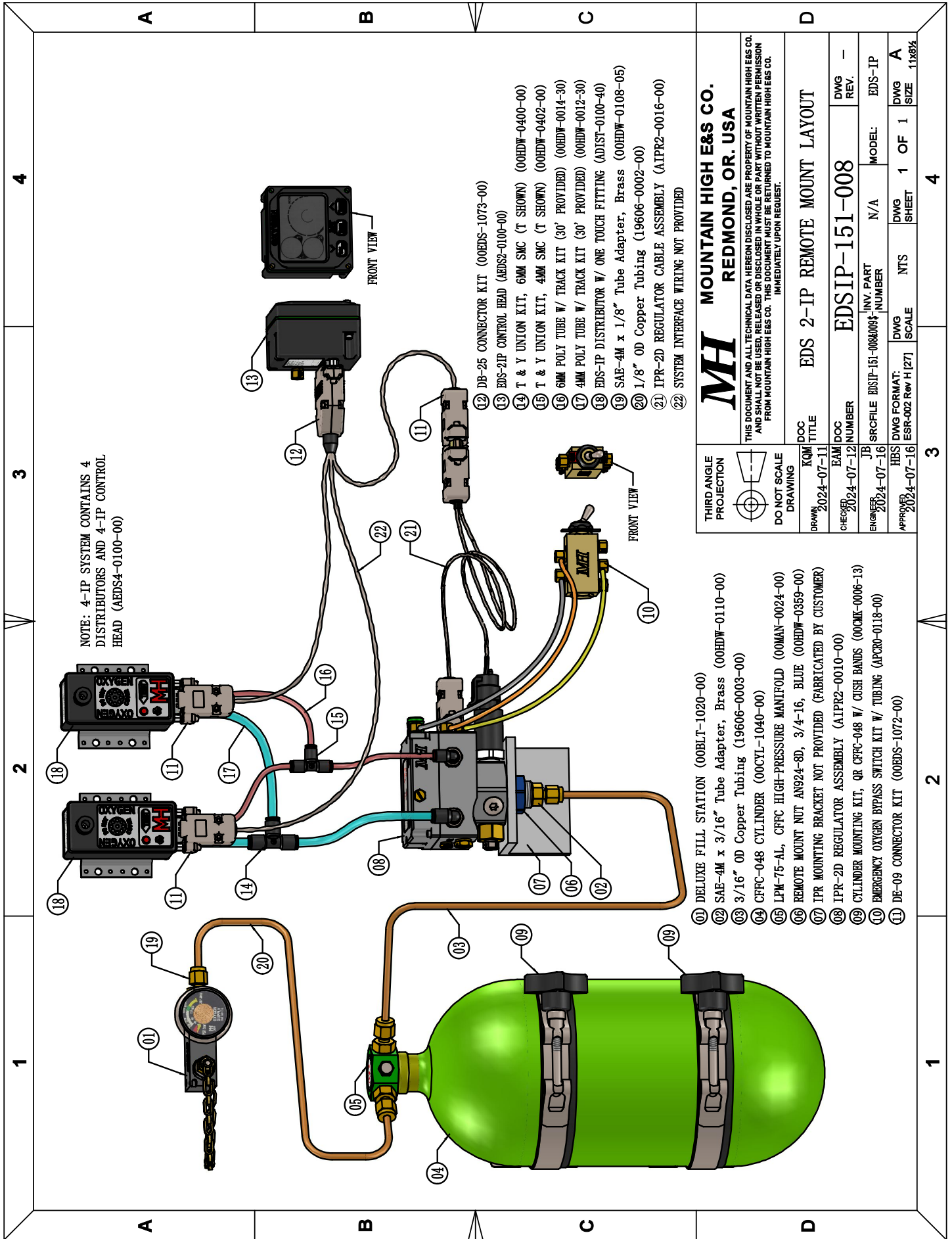

<p>THIRD ANGLE PROJECTION</p>		<p><b>MH MOUNTAIN HIGH E&amp;S CO. REDMOND, OR. USA</b></p> <p>THIS DOCUMENT AND ALL TECHNICAL DATA HEREON DISCLOSED ARE PROPERTY OF MOUNTAIN HIGH E&amp;S CO. ANY UNAUTHORIZED USE OR REPRODUCTION OF THIS DOCUMENT IS STRICTLY PROHIBITED. PERMISSION FROM MOUNTAIN HIGH E&amp;S CO. THIS DOCUMENT MUST BE RETURNED TO MOUNTAIN HIGH E&amp;S CO. IMMEDIATELY UPON REQUEST.</p>	
<p>DO NOT SCALE DRAWING</p>		<p>DOC TITLE</p> <p>EDS 2-IP REMOTE MOUNT LAYOUT</p>	
<p>DRAWN</p> <p>2024-07-11</p>		<p>DWG REV.</p> <p>—</p>	
<p>CHECKED</p> <p>2024-07-12</p>		<p>EDSIP-151-008</p>	
<p>ENGINEER</p> <p>2024-07-16</p>		<p>MODEL</p> <p>EDS-IP</p>	
<p>APPROVED</p> <p>2024-07-16</p>		<p>DWG SCALE</p> <p>1 OF 1</p>	
<p>HBS</p> <p>ESR-002 Rev H [27]</p>		<p>DWG NTS</p> <p>11x8 1/2</p>	

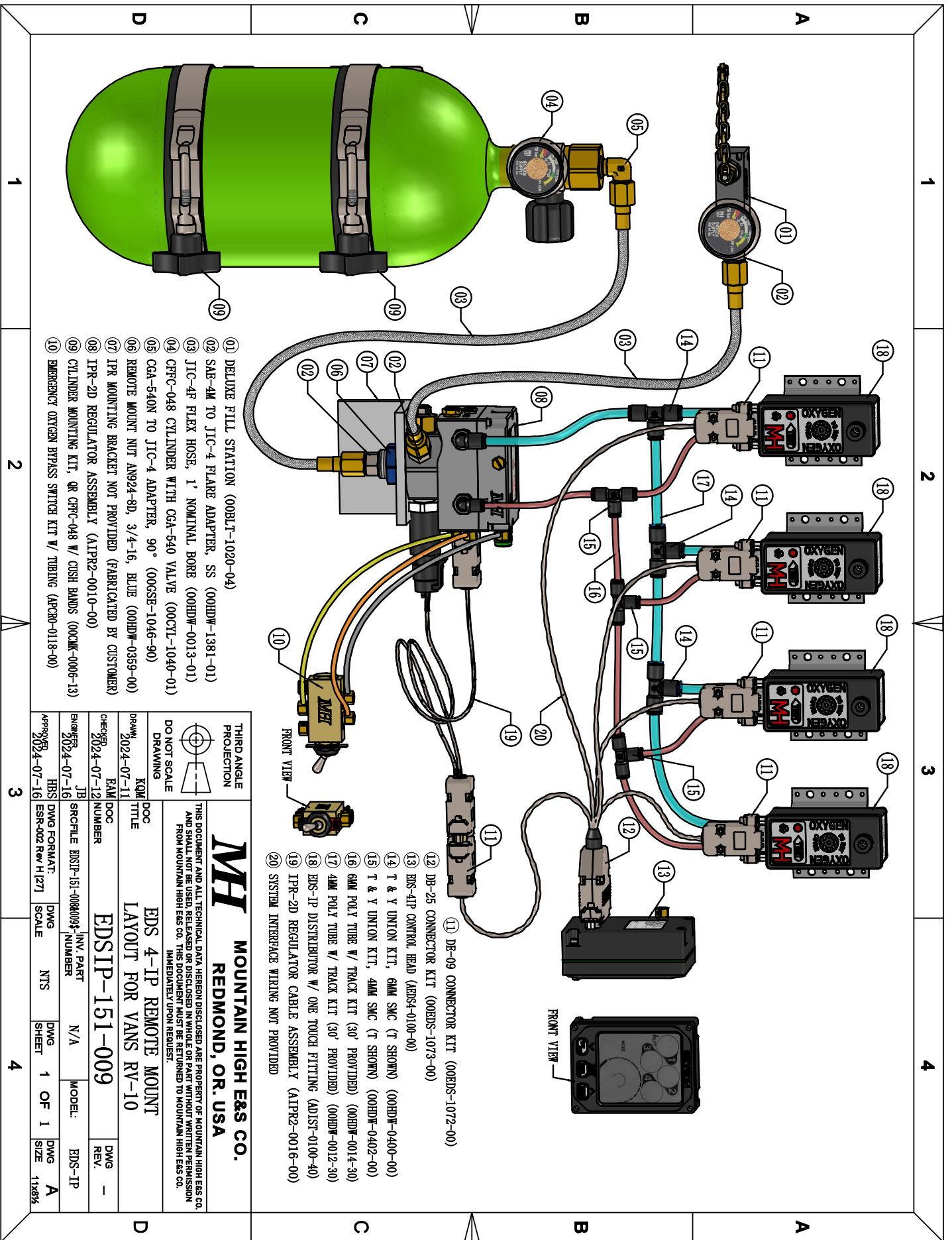

- 01 DELUXE FILL STATION (00BLT-1020-04)
- 02 SAE-4M TO JIC-4 FLARE ADAPTER, SS (00HDW-1381-01)
- 03 JIC-4F FLEX HOSE, 1' NOMINAL BORE (00HDW-0013-01)
- 04 CPFC-048 CYLINDER WITH CGA-540 VALVE (00CYL-1040-01)
- 05 CGA-540N TO JIC-4 ADAPTER, 90° (00GSE-1046-90)
- 06 REMOTE MOUNT NUT AN924-8D, 3/4-16, BLUE (00HDW-0359-00)
- 07 IPR MOUNTING BRACKET NOT PROVIDED (FABRICATED BY CUSTOMER)
- 08 IPR-2D REGULATOR ASSEMBLY (AIPR2-0010-00)
- 09 CYLINDER MOUNTING KIT, OR CPFC-048 W/ CUSH BANDS (00CMK-0006-13)
- 10 EMERGENCY OXYGEN BYPASS SWITCH KIT W/ TUBING (APCR0-0118-00)

- 11 DE-09 CONNECTOR KIT (00EDS-1072-00)
- 12 DB-25 CONNECTOR KIT (00EDS-1073-00)
- 13 EDS-4IP CONTROL HEAD (EDS4-0100-00)
- 14 T & Y UNION KIT, 6MM SMC (T SHOWN) (00HDW-0400-00)
- 15 T & Y UNION KIT, 4MM SMC (T SHOWN) (00HDW-0402-00)
- 16 6MM POLY TUBE W/ TRACK KIT (30' PROVIDED) (00HDW-0014-30)
- 17 4MM POLY TUBE W/ TRACK KIT (30' PROVIDED) (00HDW-0012-30)
- 18 EDS-1P DISTRIBUTOR W/ ONE TOUCH FITTING (ADJST-0100-40)
- 19 IPR-2D REGULATOR CABLE ASSEMBLY (AIPR2-0016-00)
- 20 SYSTEM INTERFACE WIRING NOT PROVIDED

THIRD ANGLE PROJECTION  
DO NOT SCALE  
DRAWING

**MH** MOUNTAIN HIGH E&S CO.  
REDMOND, OR, USA

EDS 4-1P REMOTE MOUNT  
LAYOUT FOR VANS RV-10

EDSIP-151-009

THIS DOCUMENT AND ALL TECHNICAL DATA HEREON DISCLOSED ARE PROPERTY OF MOUNTAIN HIGH E&S CO. AND SHALL NOT BE USED, REPRODUCED, RELEASED OR DISCLOSED IN WHOLE OR PART WITHOUT WRITTEN PERMISSION FROM MOUNTAIN HIGH E&S CO. THIS DOCUMENT MUST BE RETURNED TO MOUNTAIN HIGH E&S CO. IMMEDIATELY UPON REQUEST.

DESIGNED BY	DATE	CHKD BY	DATE	APP'D BY	DATE
J.B.	2024-07-11	EAM	2024-07-11	HBS	2024-07-16
ENGINEER	DATE	DESIGNED BY	DATE	APP'D BY	DATE
HBS	2024-07-16	J.B.	2024-07-11	HBS	2024-07-16
DWG NO.	REV.	DWG NO.	REV.	DWG NO.	REV.
151-009	00	151-009	00	151-009	00
DWG NO.	REV.	DWG NO.	REV.	DWG NO.	REV.
151-009	00	151-009	00	151-009	00

## ***Basic Theory of EDS Technology***

The EDS (Electronic Delivery System) utilizes well-known human respiratory physiological facts to provide the most efficient, yet smallest and lightest, aviation oxygen system available. The EDS monitors micropressure changes in human breathing, delivering a precise pulse of oxygen at the instant each inhaling cycle is detected. Precious oxygen that is otherwise lost (over constant-flow systems) is saved by using the pulse-demand system. Oxygen is not wasted during times it is not needed with the EDS pulse-demand system. Because constant-flow systems simply spill excessive amounts of precious oxygen, many pilots wait until some indication of hypoxia is detected before they begin to use what supply of oxygen they may have. If a person does not recognize the indications of hypoxia, it can result in their being well behind the oxygen saturation curve from the start, resulting in serious judgment flaws.

Each station distributor is an independent oxygen-delivery unit constantly gathering respiratory physiological information for each person. A respiration profile is then made for each person connected. Operating modes, pressure altitude, exposure factor (rate of ascent & duration) and cylinder pressure information are also gathered from the control head. Together, this information allows the EDS to achieve true physiological adaptiveness.

The EDS system has the ability to virtually monitor and profile the physiological aspects of each person connected. In fact,  $O_2$  saturation can be estimated by respiratory profiling. The EDS-ip (intelligent peripheral) system provides the correct amount of  $O_2$  for various exposure factors. Further it accomodates different types of users, dispensing only the amount of oxygen needed to help yield-correct oxygen saturation factors.

The patented 'synchronous inhalation pulse-demand technique' used by the EDS is currently the most efficient way, known by respiratory physiologists, to saturate the blood to well over 90%. It accomplishes this using as little as 1/8 the oxygen over standard constant-flow systems. The average user may see a 6-to-8 time savings because of these adaptation factors.

Since its introduction in 1992, the EDS Pulse-demand™ method of delivering oxygen to an individual at various altitudes has set new standards in the aviation SBA (Supplementary Breathing Apparatus). The EDS-2ip and 4ip are complete two- and four-place Pulse-demand™ aviation oxygen systems that can be built into instrument panels or overhead consoles in a variety of aircraft.

## ***Physiological Factors***

The breathing cycle of a normal, healthy, non-smoking person is such that about one-third is spent inhaling while two-thirds is spent exhaling and pausing. In addition, the human lungs, for their size, are relatively inefficient compared to other organs. The human lungs are easily stressed at high altitudes, affecting the entire body within seconds. This is partly because only a fraction of inhaled air (25% to 30%) actually gets to the  $O_2/CO_2$  exchange area of the lungs. The rest is spent in the 'dead-space' areas such as the trachea, bronchus, and other areas not directly contributing to oxygen absorption. Then the air, with this  $O_2$ , is simply exhaled back out. Studies have shown that one greatly benefits from the pulse-demand method of  $O_2$  being delivered at the very beginning of inhalation cycles. With this, the  $O_2$  flows into the most functional part of the lungs, allowing optimum oxygen absorption during high-altitude excursions.

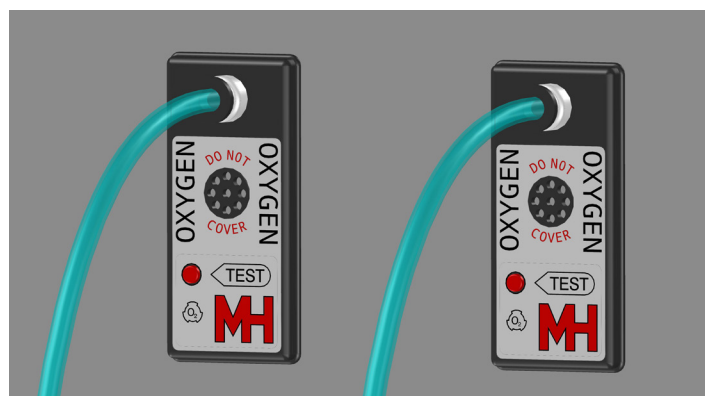

***The EDS-ip technology  
is engineered and  
made in the USA***



### **NOTICE REGARDING MATERIALS**

#### **Material Compatibility and System Design Statement:**

Materials such as aluminum, iron, steel, polymers and brass commonly used in any oxygen systems may ignite and burn under certain severe and adverse conditions. Although these conditions may be rare they are nonetheless possible in a high-pressure pure oxygen environment. Design and manufacturing rules have been applied to this product to ensure the maximum amount of safety and compatibility with high-pressure oxygen. The EDS 2ip-4ip system has been designed with maximum margin of safety while providing the most capable and lightest system suitable for aircraft applications.

#### **Material And Design:**

To ensure the best margin of operational safety the main body of the IPR-2DL is machined from 6061-T651 PER QQ-A-225/8 Aluminum. The wetted parts (parts that come in direct contact and control high pressure oxygen) are made from CDA-360 brasses or 303 or 304 stainless steels. Where applicable the design guidance and rules for the IPR-2DL pertain to ASTM standard guide for designing systems for oxygen service G88-90 also G63, G93 and G94. Cleaning protocol was adopted from SAE-AIR1176A and other documents from CGA and ASTM. In addition, the IPR-2DL has a stainless steel mesh disk filter inside the main inlet port. It is therefore the duty of the installer and user of the system to ensure that clean and proper practices are used to install, fill and use the system.

### **SAFETY NOTICE FOR HIGH PRESSURE OXYGEN MANAGEMENT SYSTEMS**

Factors recognized as causing fires in oxygen systems

#### **Temperature:**

As the temperature of a material increases, the amount of energy that must be added to produce ignition for combustion decreases. Operating an Oxygen system at unnecessarily high temperatures, whether locally or generally, reduces this safety margin. The ignition temperature of the many materials commonly used in oxygen systems is lowered in materials that otherwise might be self-extinguishing.

#### **Contamination:**

Inadequate cleanliness during assembly, installation or service may cause contamination of oxygen systems. Abrasion and deterioration of system components over time may also cause contamination. Contaminates can be highly flammable and easily ignited. They may be introduced as liquids, solids or gases. Hydrocarbon oils such as hydraulic or engine oil are good examples. Even normally inert contaminants such as rust may produce ignition through particle impacts, friction and resonance heating effects.

#### **Particle impact:**

Collisions of inert or ignitable solid particles in a high pressure oxygen enriched environment are associated with potential ignition. Such ignitions may result from the particle being flammable and igniting upon impact and, in turn, igniting other system materials. Ignition may also result from heating of the particles and subsequent contact with system polymers, from fine flammable particles produced during collision, or from the direct transfer of kinetic energy during collision. Absolute removal of particles is not possible, and systems can self generate some particles from normal operation. The IPR-2DL system has been designed to minimize this potential and filters are present at all of the high pressure inlet ports. The hazard associated with particles increases with both heat and temperatures of the system and the kinetic energies of the particles. It should be noted that the quantity of particles in a system will tend to increase with time and usage.

#### **Responsibility:**

It is the duty of the installer and user of the system to ensure that clean and proper practices are used to install, service and use the system.

#### **Pressure:**

As the pressure of oxygen in an oxygen system increases, the ignition temperatures of its components typically decrease, and the rates of fire propagation increases. Therefore, operating an oxygen system at unnecessarily high pressures increases the probability of a fire. It should be noted that a pure oxygen environment, even at atmospheric pressures, may still pose a significant hazard with materials that are not compatible such as hydrocarbon oils.

#### **Heat from compression:**

Heat is generated from the conversion of a gas going from a low pressure to a high pressure rate. This typically occurs during a system filling operation. In addition, it occurs when high pressure oxygen is released into a dead-ended tube or pipe quickly compressing the residual oxygen that was in the tube or pipe ahead of it. The elevated temperatures produced can ignite contaminants or elevate system components above their ignition point. The hazard of heat from compression increases with system pressure, pressurization rates and temperature.

#### **Resonance:**

Acoustic oscillations (whistling-chatter) within resonant cavities are associated with rapid heating. The temperature rises more rapidly and achieves higher values where particles are present or where there are high gas velocities. Resonance phenomena in oxygen systems are well documented, but there are few design criteria.

#### **Static electric discharge:**

Electrical discharge from static electricity, possibly generated by high fluid flow under certain conditions, may occur, especially where particle contaminants are present. Composite fiber wound cylinders do not present any static electricity hazards unless they are not electrically part of the metallic components of the system or have the internal envelope (liner) ungrounded. Make sure your installation includes grounding the composite cylinder at the metallic point of the neck to the common ground point of the aircraft system.

## ***General Specifications of the EDS-ip systems***

Specifications, performance standards and limits are derived from actual units tested, characterized or calculated.  
Specifications are subject to change without notice.

Operating Voltage (pin 1): 11 - 32 VDC. Automatic voltage selecting for 14- or 28-volt systems.  
Reverse voltage protection: Series Shotkey-type Diode

Currents below are measuring a 2ip control head and two DIST units only and do not include any currents expressed by the electronic pressure sending units or IPR. (Add ~ 75 mA to include IPR & ~ 20 mA MAX for each sending unit)

Operating Current @ 14 VDC (OFF 'standby state'): ~ 19 mA (~22 mA with lights on full)  
Operating Current @ 14 VDC (ON): ~50 mA avg. ~ 164 mA peak (including initial turn-on phase)  
Operating Current @ 14 VDC (ON with two stations breathing @ 10K ft.): ~50 mA avg. ~116 mA peak. (lights on or off)

Operating Current @ 28 VDC (OFF 'standby state'): ~ 11 mA (~13 mA with lights on full)  
Operating Current @ 28 VDC (ON): ~28 mA Avg. ~ 92 mA peak (including initial turn-on phase)  
Operating Current @ 28 VDC (ON with two stations breathing @ 10K ft.): ~28 mA avg. ~68 mA peak. (lights on or off)

Operating Current for IPR: ~75 mA @ 10 VDC (powered from control head via DIST power)

DIST power outputs (pins 4, 5, 17, 18 & 19) +10 VDC @ 2 amps MAX. On only while system is active.

Gauge inputs (pins 6 & 20): 4-20 mA into a 25 $\Omega$  @ 100 nf load-to-ground @ 10 - 32 VDC (across sending unit).  
Gauge range: Tank pressure 0 - 3,150 psig., regulator pressure 0 - 31.5 psig., PA 0 - 31.5K ft.

Lights input (pin 29): 0 to 14 or 28 VDC loaded into 15K $\Omega$  / 100nf load-to-ground. 0 - 14 or 0 -28 VDC.  
Audio output (pin 9): 0 to 100 mV PP @ ~1,000  $\Omega$  (microphone-level compatible)  
Alert / Alert drive (pin 8): Normally open ground-start contact (solid-state relay) to ground @ 3 amps MAX.  
RCV / IPR drive (pin 7) Normally open ground-start contact (solid-state relay) to ground @ 3 amps MAX.  
Data communications TX to DIST units (pins 22, 23, 24 & 25): RS-232 levels.  
Data communications RX from DIST units (pins 10, 11, 12 & 13): RS-232 levels.

### **Operating temperature, humidity, vibration & shock (assumes nominal operating voltage):**

Minimum: 0% RH @ -40° C to +60° C. (LCD readability not guaranteed @ extremes)  
Nominal: 25% RH @ +25° C.  
Maximum: 100% RH @ +50° C. near condensing. (Unit is not water-proof)  
Vibration: Random vibration 5 to 500 Hz, 15 minutes per axis @ 4.0 g. (rms.) sine wave.

### **DIST units operating inlet pressures:**

DYNAMIC 1 bar (15 psig.) (flowing) through cannula and DIST unit  
STATIC (non-flowing) 2.2 bar (35 psig) MAX.

### **Allowable respiration rates:**

Adaptive: 0-10K ft. = 20 BPM, 12-20K ft. = 22 BPM, 21 through 25K ft. = 25 BPM, 26 and over = 30 BPM, Fixed @ 30 BPM if PA is past 30K ft.

### **Apnea 'time-out' envelope:**

Adaptive: ~40 sec Pa. 0-12K ft., ~30 sec. Pa. 13-18K ft., 20 sec. at and above Pa. 18K ft.

### **System Weight (2ip & 4ip):** Approx 20lbs

(Note: This weight is provided for planning and reference only and should not be used for calculating a new aircraft weight and balance. Customer to verify their total system weight through direct measurement.)

### **Service Intervals:**

IPR overhaul period: 5 years (may coincide with hydrostatic testing)  
Cylinder hydrostatic test: Generally, every 5 years  
Control head & distributors: As required

Note: Composite cylinders have a 15-year lifespan from the date of manufacture.



**MH**  
 Aviation Oxygen Systems  
**MOUNTAIN HIGH**  
 Equipment & Supply Company

2244 S.E. Airport Way, Suite 100, Redmond, OR. 97756-7537 U S A  
 800-468-8185 World Voice: 541-923-4100 World Fax: 541-923-4141 www.mhoxygen.com