

EDS-2ip and EDS-4ip Aviation Oxygen Systems

OPERATING & REFERENCE MANUAL

For control head firmware release 9e and above



MH
Aviation Oxygen Systems

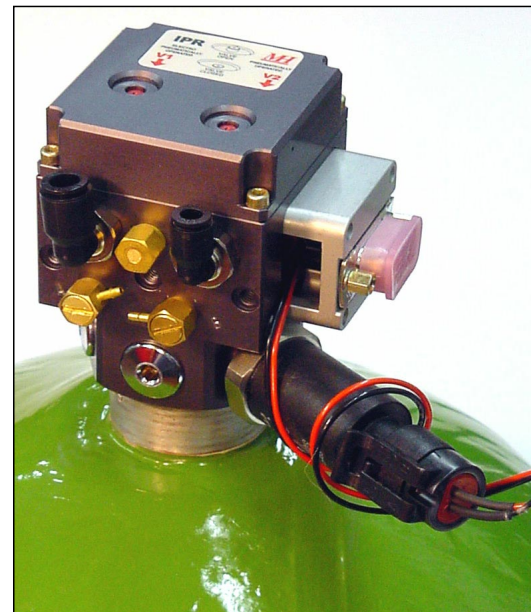

*Physiologically Adaptive Aviation Oxygen Systems utilizing patented
EDS Pulse Demand™ and Intelligent Peripheral™ Technology by Mountain High*

Table of Contents

IP System Description	1
LCD Icons, Functions, Definitions & Meanings	2
Basic System Operation and LCD Icons	3 - 5
Turn the System ON	3
Class-A Airspace / Face Mask mode	4
Low Tank / Cylinder Pressure Warnings	4
If the system has a problem	5
Emergency Oxygen Bypass Switch	5
Customizing System Settings	6
Keypad Function Guide	6
Customizing Control-Head Settings	7
Customizing Station Settings	8
Oxygen Profile & Function Delivery Schedule	9
D Mode 'Trip-Point' Schedules	9
Restoring Settings to Factory Defaults	10
Calibrating the Pressure Sending Units	10
EDS Cannulas and Face Masks	11
Oxygen Distributor (Station Outlets) Description & Operations	12 - 13
Control Head Dimensions & Hole Specifications	14 - 15
Basic IPR Components & Suggested Installation Layouts	16 - 17
Reference Drawings & Technical Information	18 - 23
Specifications: Electrical & Pneumatic	24

EDS-ip Built-in Pulse-demand Aviation Oxygen System Description

Congratulations on choosing the Mountain High EDS ip system, the international standard for aviation oxygen systems. The ip stands for *intelligent peripheral*, meaning each oxygen outlet station has a micro-computer that constantly monitors respiratory aspects of each person. Through the cannula or face mask, the ip system characterizes the physiological respiratory profile to adapt to individual needs and situational awareness. In addition, the ip system gleans a good approximation of a persons PaO₂ saturation (amount of O₂ carrying blood cells that are able to carry O₂ to the body) ensuring that the proper amount of oxygen is delivered at various altitudes. The ip system is a completely integrated, adaptive, intelligent aviation oxygen system. No other aviation oxygen system can provide such conservation of your oxygen with unmatched safety and comfort.

Basic ip system configuration

The EDS ip (Electronic oxygen Delivery System, intelligent peripheral) has four (4) main parts:

- 1) The ip System Control & Display Head
- 2) Oxygen outlets / Distributor Stations
- 3) The oxygen source (Tank / Cylinder) & IPR regulator.
- 4) Emergency bypass control switch

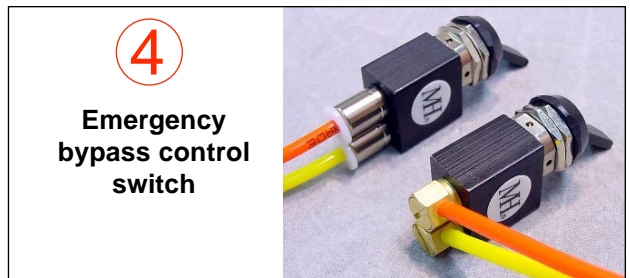
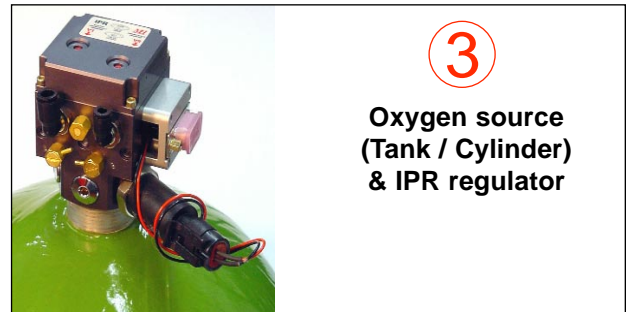
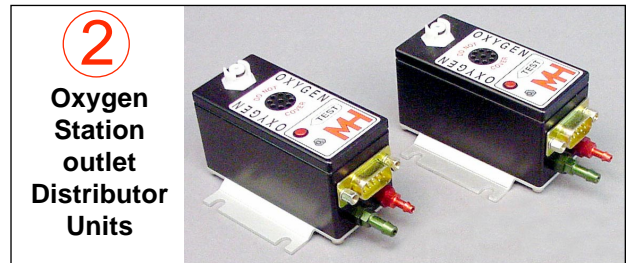
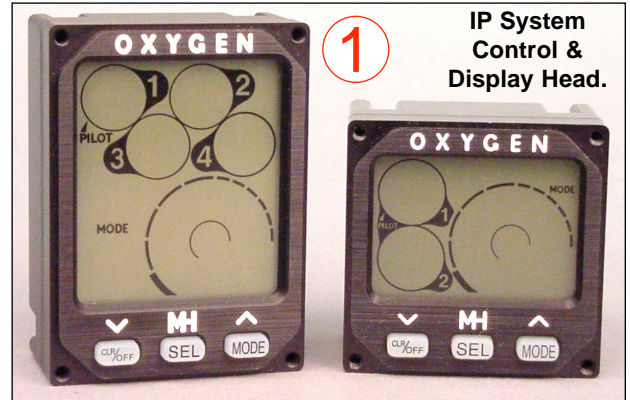
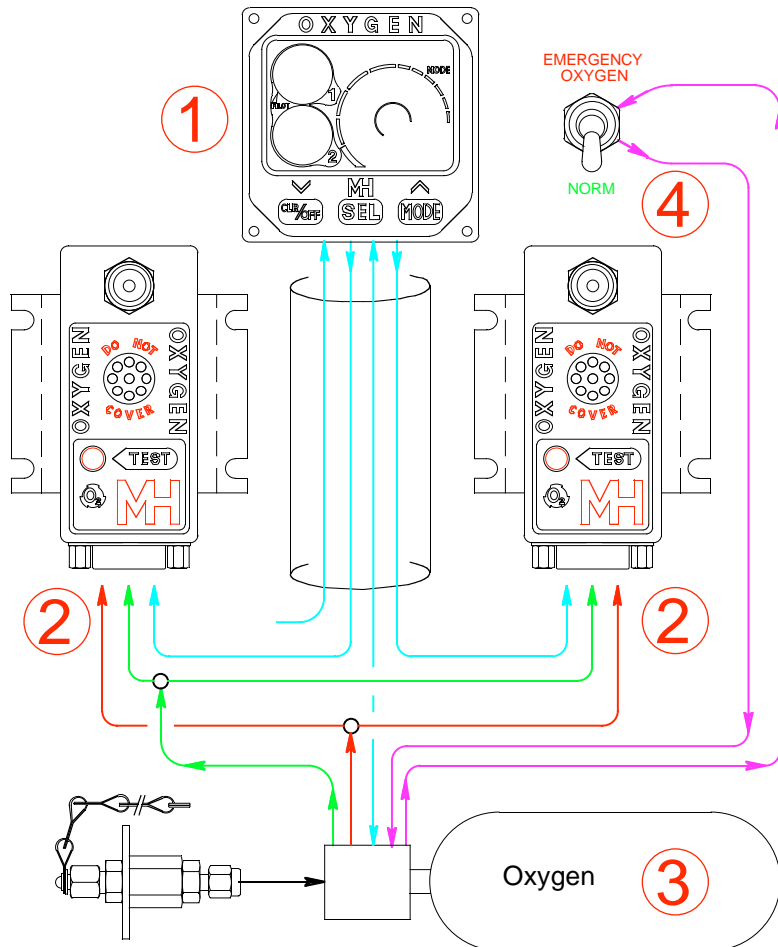

The **EDS-2ip** is a two-place system engineered to fit into the standard area for a 2.25" instrument hole.

The **EDS-4ip** is a four-place system engineered to fit into a 2.25" wide by 3.125" tall instrument hole. Both of these lighted control heads can be configured to fit into almost any aircraft installation including an overhead console requiring only ~1.75" of depth.

2ip
LCD

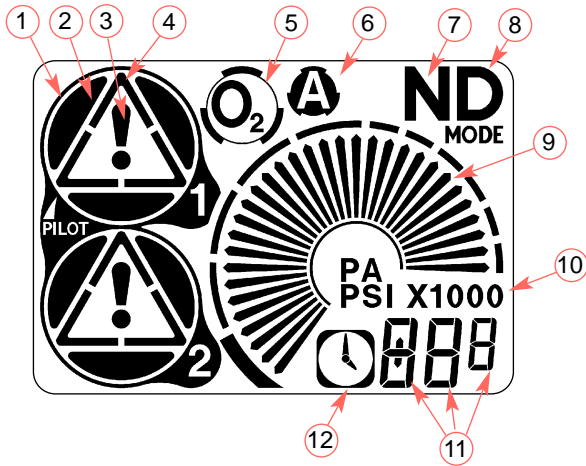

- ① **Station Status Circle**
Everything unique to the stations will show up in these circles
- ② **Station O₂ Flow-flags**
Shows station has responded with a pulse of oxygen
- ③ **Station Active inspiration response**
This icon alone will show every time a valid inspiration effort has been detected or the red button has been pressed on that station DIST unit.
- ④ **Station Alert icon**
Shows for Apnea, flow-faults, missing stations
- ⑤ **O₂ Alert Icon**
Shows during situations where oxygen may not be properly delivered or where O₂ supply may be an issue.

- ⑥ **Dual purpose Icon**
While system is ON this icon shows that the system is operating in 'Class-A' mode, a Pressure Altitude (PA) at and above 17.5 K ft. While system is OFF this icon shows that the Auto-On feature is armed to turn the system on at a PA of about 11 K ft.

This icon flashes if the system has been turned off after it came on by the Auto-on feature. Once you descend below a PA of ~10 K ft. it will stop flashing to indicate that the Auto-on feature is still active and armed.



- ⑦ **NIGHT (now / normal) mode**
System will respond with O₂ at all pressure altitudes regardless of any preset D mode trip points. *Pages 3, 8 & 9*
- ⑧ **DAY (delayed) mode**
System will delay response of O₂ until the pressure altitude is at or above the preset D-mode trip-points. *Pages 3, 8 & 9*

4ip
LCD

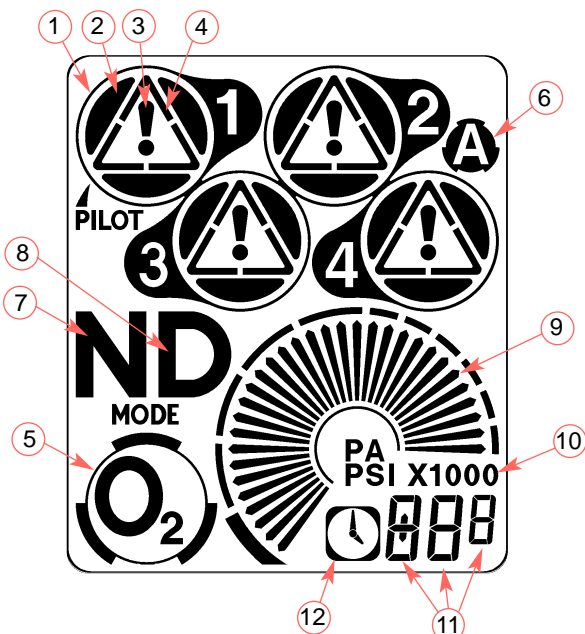

- ⑨ **Analog display**
Compliments digital readout with cylinder pressure, pressure altitude and regulator outlet pressure if the optional low-pressure regulator pressure sending kit is installed.
- ⑩ **Display Mode**
Compliments analog & digital display
 - a) PA X1000 Pressure Altitude: 0 - 31,500 ft.
 - b) PSI X100 Cylinder pressure: 0 - 3,150 psig.
 - c) PSI (optional) Regulator pressure: 0 - 31.5 psig.
- ⑪ **Digital ReadOut**
Compliments analog the display readings with numerical data. The small right hand digit represents different scales per display mode.
 - a) Hundreds (100) of ft. while in PA.
 - b) Tens (10) of psig. while in Tank / Cylinder pressure.
 - c) Tenths (1/10) while in regulator pressure readout.
- ⑫ **Time / clock icon**
Shows a time constrained condition such as low O₂ supply alerts.

NOTE:

All these icons will have different meanings during times while you are in the system or station set-up modes.

While the system is OFF

Turn System ON:

SEL First the control head must be connected to power and the display showing **OFF**. To turn the system on press & release the **SEL** button. The control head will light-up all the icons, perform a series of built-in tests, and proceed to operate if no problems were found.

The **SEL** button has a dual purpose while in the **OFF** state. 1) press & hold to query the firmware version in the control head. 2) while holding the **SEL** button down, press and hold the **MODE** button to query the control head option code.

Auto-On Feature:

MODE Press & hold the **MODE** button for ~2 seconds to toggle the auto-on feature. The auto-on feature is armed if the **A** icon is on. This allows the system to automatically power-on once a pressure altitude of ~10,000 ft. is detected.



Please note that the **A** is a dual purpose icon depending if the system is **ON** or **OFF**!
 1) Auto-On mode armed while the system is **OFF**.
 2) Class-A mode active while the system is **ON**.

Actions the buttons perform are different while the system is ON or OFF.

	While On	While Off	CLR/OFF	SEL	MODE	MODE
Button Click		Clear Alerts	Power System Up	Gauge Select		Toggle D & N modes
Button Held-Down	Clear Error Codes	Power System Down	Query rev level	Enter Set-up mode	Toggle Auto On	Toggle Class A mode

If the master switch is turned off while the system is on it will remember that it was on and will come back on when the master is switched back on.

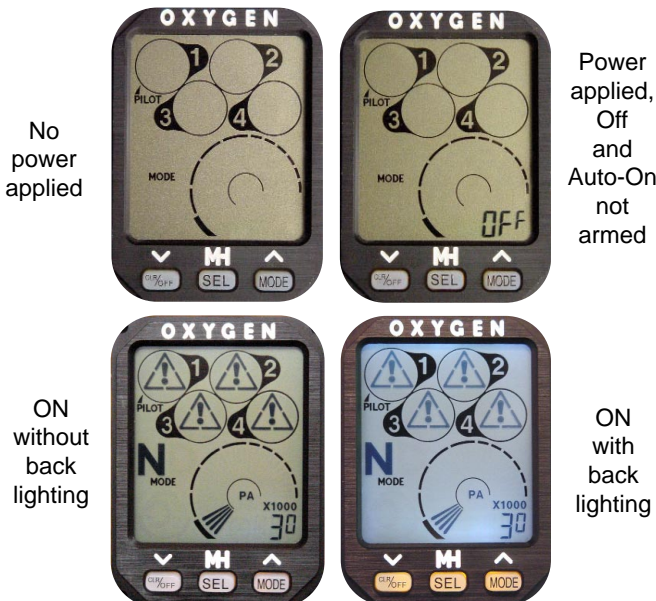

While the system is ON

Turn System OFF and clearing alerts:

CLR/OFF To turn the system off simply press and hold the **CLR/OFF** button until the unit shows **OFF**. This will require the button to be held down for ~2 seconds. This long hold time is by design in an effort to prevent the system from being turned off by accident. Clear any of the alert conditions such as apnea with short hits of this key.

Special considerations with the OFF button and the Auto-on feature:

A flashing 'A' icon, while in the OFF mode, indicates that you turned the system off at or above a PA of ~11K ft. while the auto-on feature is active. A steady 'A' icon, while in the OFF mode, indicates that the auto-on feature is armed and the system will automatically become active (turn-on) once a PA of about 11K ft. is detected.



Basic Operating Modes N & D:

MODE The control head has two basic modes of operation; **N** and **D** mode. You can toggle the unit between the modes with the **MODE** key. Both modes deliver the same amount of oxygen as a function of pressure altitude.

The **N** shows you are operating in night (also called *now or normal*) mode and delivers oxygen on-demand at all pressure altitudes. On power-up the unit defaults into the **N** mode. The system automatically goes to **N** mode and will not allow **D** mode settings if the light input indicates the lights are on. In addition, the LEDs on the distributor units act differently while the lights are on or off. See page 12 for details.

The **D** shows you are operating in Day (also called *delayed*) mode. The user can pre-select any one of 8 pressure altitude settings from 4K ft. to 11K ft. (see setting the **D** trip points page 8). The only difference between the **N** & **D** modes is **D** mode delays delivering oxygen on-demand until a certain pressure altitude is achieved.

Analog & Digital Pressure Gauge Display:

The control head has an analog graphical arc and digital gauge to allow the monitoring of different analog inputs. Power-on default for the gauge readout is tank / cylinder pressure.

SEL Press & release the **SEL** button to make analog & digital gauge readout selections to allow the monitoring of the following:

- a) Hundreds (100) of ft. for Pressure Altitude readout.
- b) Tens (10) of psig. for Tank / Cylinder pressure readout.
- c) Tenths (1/10) for regulator pressure readout.
Visible only if the optional regulator sending unit is installed.

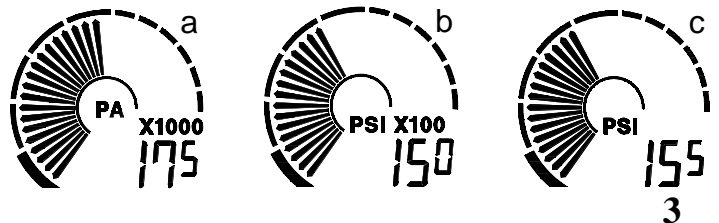

Basic System Operation and LCD icons

Class-A Airspace / Face Mask mode:

At and above a pressure altitude of about 17,500 feet, the system will automatically switch to class **A** mode. The **A** icon will flash to alert users that face masks should be used instead of cannulas. The **CLR/OFF** key will clear the alert and the **A** icon will then go on steady to indicate the unit is operating in class **A** mode. The unit will stay in the class **A** mode until a pressure altitude just below 10 K ft. is detected. This function will cycle for every time you ascend and descend through these altitudes. While in the **A** mode, the active oxygen delivery curve automatically becomes a slightly richer flow rate for use with face masks. (see page 9).

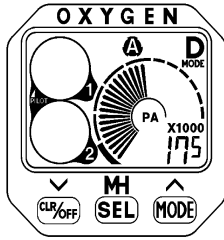

Pressing and holding down the **MODE** button for ~2 seconds will toggle the Class-A airspace mode manually on or off as indicated by the **A** icon. While the system is manually placed into the class **A** mode and, if the system ascends through a pressure altitude of 17,500 ft., the **A** icon will flash to alert that face masks should be used instead of cannulas.

Low Tank / Cylinder Pressure, 1st Warning:

The EDS-ip control head constantly monitors the oxygen cylinder pressure. If it drops to ~500 psig., it will alert that the O₂ is low and in a time constrained condition with the clock and O₂ icon and an audio beep if connected to the intercom system.

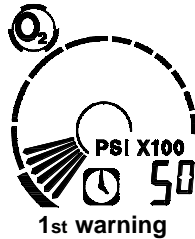

Low Tank / Cylinder Pressure, 2nd Warning:

A more urgent alert, also with an audio beep, if connected to the intercom system, will show once the tank pressure drops to ~200 psig., alerting that your supply of oxygen is very low and in a more urgent time constrained condition with the clock icon and the O₂ icon flashing red.

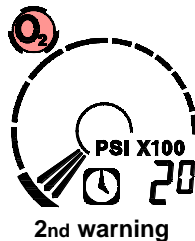

If the electrical cylinder pressure sending unit fails or has become disconnected, the digital display will read - - and the bar graph will show nothing, indicating that it is not operating. The low tank pressure 2nd warning will then alert.

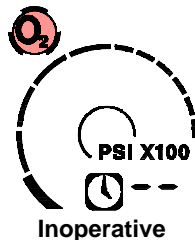

Clear these alerts via the **CLR/OFF** button. The **clock** icon will go steady if at the first warning and flash on the second warning after clearing.

Respiration response:

Any one of the station status circles will flash the ! icon for each valid inspiration event detected. No oxygen is dispensed in association with this icon. It will be common while in the **D** mode and operating below the preset pressure altitude trip-point indicating that a station is operating.

Flow response & Idle:

Any one of the station status circles will show a steady 3-point crescent icon 1) for about 2 seconds for each valid inspiration event detected and complemented with oxygen. In the event that an additional inspiration effort is detected before another flow response is allowed, the '!' will show 2). This will be quite normal and simply indicates that person on that station is breathing over the maximum allowable respiration rate. Idle stations show nothing 3).

Oxygen Flow Fault:

Any one of the station status circles will show the ISO alert icon in association with the Oxygen Alert icon for about 3 seconds along with an audio chime after an inspiration effort where oxygen did not flow when it otherwise should have. This is called the flow fault alert and can be from any of the following reasons:

1. The oxygen supply has been removed, turned off or has run empty.
2. The supply line has become pinched off, disconnected, obstructed or the primary regulator has failed.
- 3) The Station unit has failed

Apnea Alert:

Once a station has been put into use and it has not detected any inspiration efforts for a period of ~40 seconds the unit will produce the apnea alert along with audio beeps through the intercom system in an effort to inform the user. Resuming respiration will automatically clear the apnea alert and oxygen will continue to flow on-demand. Apnea alert for any of the stations can be cleared with the **CLR/OFF** button. Apnea is the most common alert encountered and can be caused by any of the following reasons:

1. The feed tube to the cannula or face mask is pinched or obstructed or the outlet (cannula) tube has become disconnected, removed or not correctly placed on the person.
2. That station has detected a pressure altitude that requires the use of oxygen, but is not being used.
3. The user has paused (quit) breathing for over a 40 second period.

While the system is operating in **D** mode and if you do not already have the cannula or face mask on and connected to a station, the apnea alert will remind you to 'put-your-oxygen-on' once the system detects a pressure altitude at or past the preset **D** mode setting.

If the system has a problem:

During cold power-up (master switch on and power applied to the unit), the system performs a series of built-in tests (BIT) then prepares itself for use. If the unit was on (active) in the past, it will go directly into the on (active) state and defaults to the **N** mode, else it will only display 'OFF'. The initialization (start-up) routine establishes communications with each O₂ distributor unit, powers up the Remotely Controlled Regulator unit (RCV-RCR or IPR). The control head issues a start-up command to each station in sequence starting with station one. During such, each station distributor unit performs a BIT. A blast of O₂ will ensue to display that each station is ready. After all stations have demonstrated their readiness the system is ready for preflight test and use.

During power-up, or run-time if the Control Head BIT (Built-In Test) encounters a problem internally, where the system deems itself not usable, or with the electrical power connections to the O₂ distributor units that result in an excess power drain, the control head will (like a breaker switch) instantly shut-down and clear the LCD display showing only the letters **Err** (general error) or **Er4** (low input voltage) on the LCD. In addition, the **O₂** icon will glow red. This condition can be cleared with the **CLR/OFF** button. Error conditions will cause the ALM signal for an enunciator panel to go low.

To clear this error message push the **CLR/OFF** button. The system will then show **OFF**. If O₂ is needed use the emergency O₂ bypass switch.

At any time during use, if a station is not able to communicate with the control head, the status circle will constantly flash the alert icon. All other stations will operate normally.



During initial installation it is not uncommon to have the electrical power bus to one or all distributor units shorted, any of the distributor units to have the power pins reversed or the send (Tx) and receive (Rx) pins be reversed.

Only low pressure O₂ is allowed to travel to the distributors through the normal main pneumatic circuit. Stations not in use will not dispense any O₂. They will, however, automatically become active once they are put into use dispensing O₂ on demand.

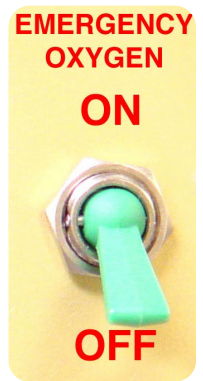
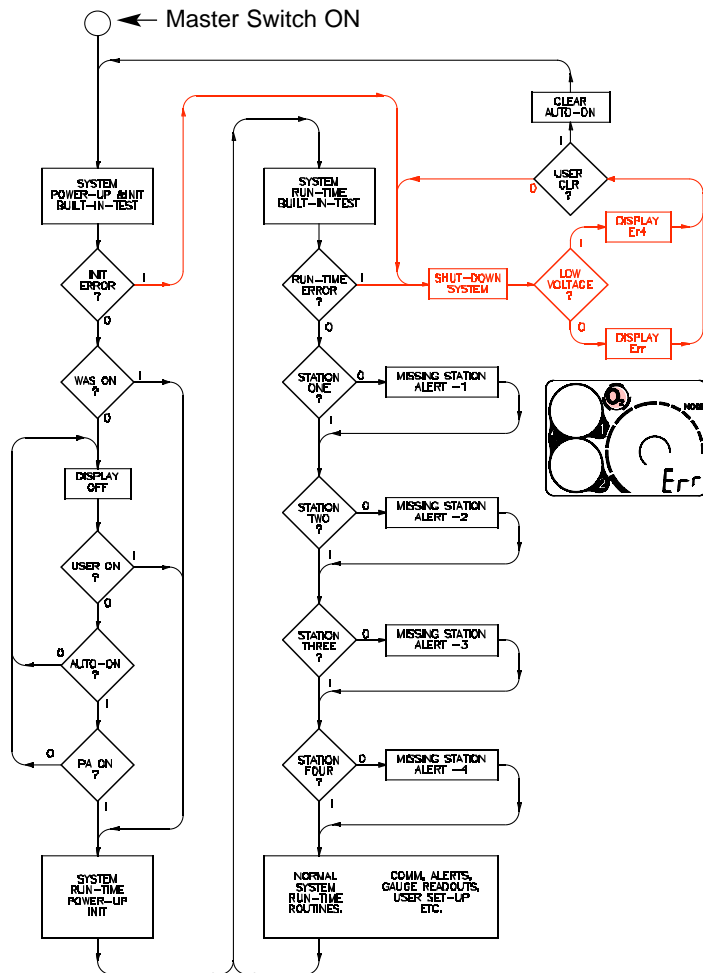

Emergency Oxygen Bypass Switch

A pneumatic toggle switch placed in the 'ON or EMERGENCY' position controls a separate bypass valve that provides O₂ to all stations at a constant flow of ~2.8 - 3.1 liters/min. This is a completely separate system not depending on the control head or the normal supply circuit of oxygen. While the emergency switch is in the 'NORM or OFF' position no O₂ is provided to the stations through the emergency bypass circuits. The emergency bypass switch can be toggled back and forth as many times as desired for testing and familiarization purposes.

Only low pressure O₂ is allowed to travel to the distributors through the emergency bypass pneumatic circuit completely bypassing the pulse demand pneumatic circuit.

You can cycle the system on and off in an attempt to clear the error. However, if the error condition does not clear and O₂ is needed, the system should be turned off and the emergency O₂ bypass switch should be used. The system should be serviced as soon as possible after landing.

Customizing System Settings

Settings for the control head can be customized for each installation or desired effect. They are: LCD contrast, LCD back light balance with aircraft lighting, key-pad back light balance and audio volume. While you are in any of these setting modes the system will continue to operate responding to users and delivering oxygen normally. However, if at any time a critical error occurs while you are in any of the setting modes, you will be immediately kicked out of the settings mode and sent back to normal operating mode so that the error can be interpreted and the correct action can be taken.

Keypad Function Guide

To enter the settings mode, *only accessible while the system is on*, press and hold the **(SEL)** button and then press the **(CLR/OFF)** or **(MODE)** button within one second. To leave any of the setting modes simply press and hold the **(SEL)** key for about three seconds. The unit will store any changes you have made and resume displaying your operational situation. If the control head does not detect any key button actions for 15 seconds it will revert back to the normal operating mode and save any changes you have made.

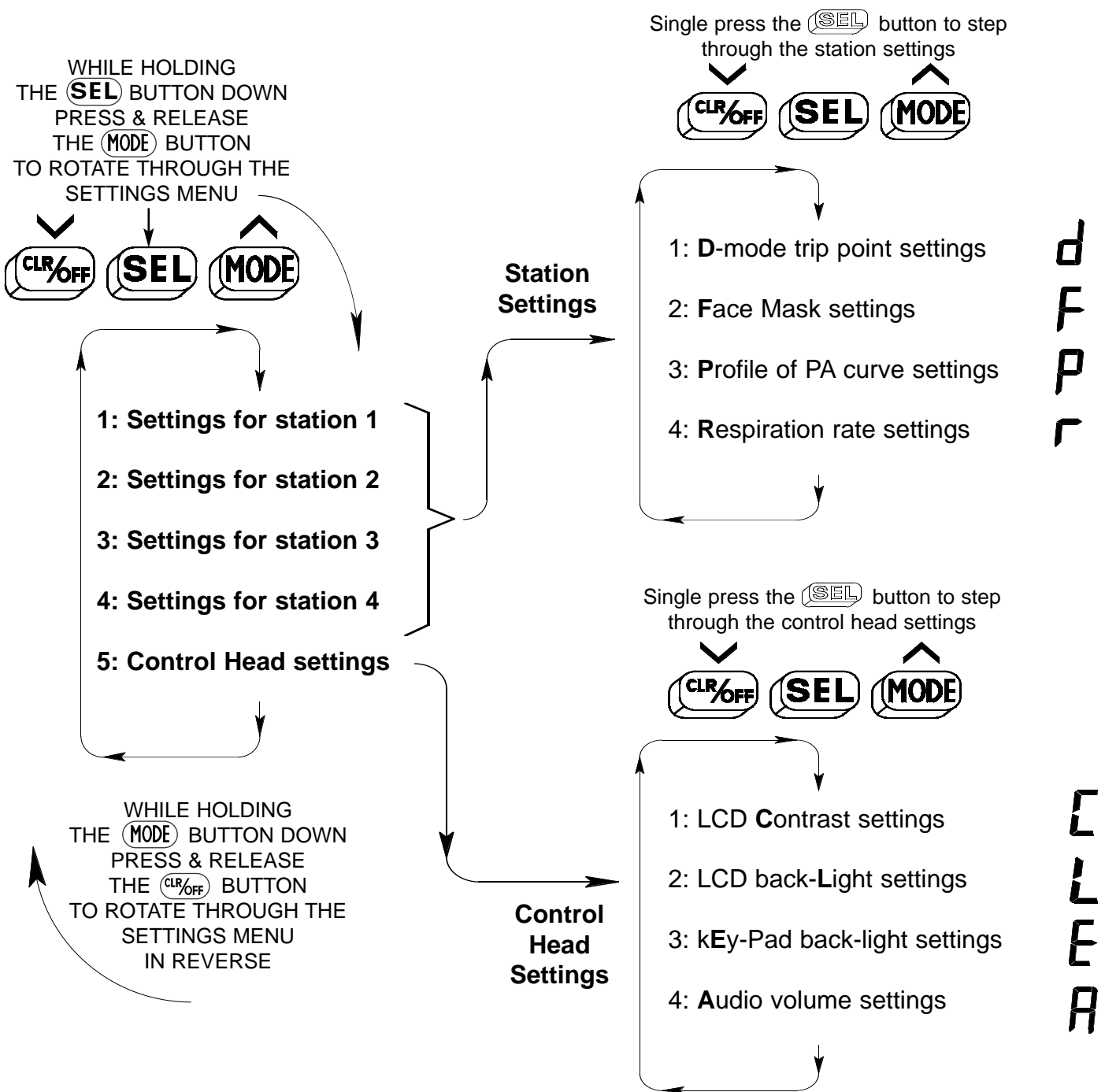

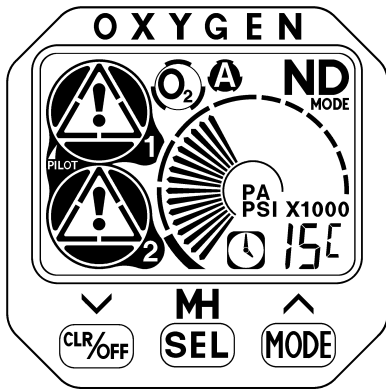

1- Adjusting the LCD contrast:

You can adjust LCD contrast for best viewing contrast while observing the unit at different angles. To do so, press & hold the 'SEL' button and while doing so (within a period of ~2 seconds) press and release the **CLR/OFF** key. You will go directly to the control-head settings. You should see the LCD display as the figure below.

Release the **SEL** button. You can now increase the LCD contrast with the **MODE** key or decrease the LCD contrast with the **CLR/OFF** key.

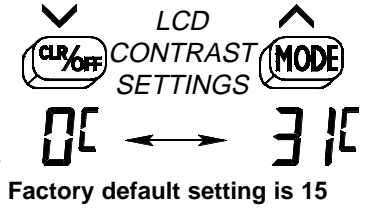

While you are in this settings mode you can move through the LCD backlight balance, button backlight balance and audio volume adjustments modes with the **SEL** button.

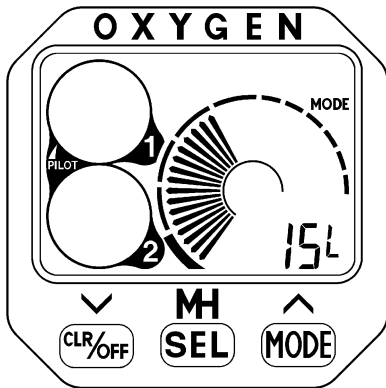

2- Adjusting the LCD backlight balance:

You can balance the brightness of the LCD back light in 32 increments with the overall panel independent of the other instruments. To do so, press & hold the **SEL** button and while doing so, and within a period of ~2 seconds, press and release the **CLR/OFF** key. You will go directly to the LCD contrast adjustment menu. Press & release the **SEL** key once to go to the desired LCD backlight balance setting. You can now increase the LCD back light with the **MODE** key and decrease the LCD backlight with the **CLR/OFF** key.

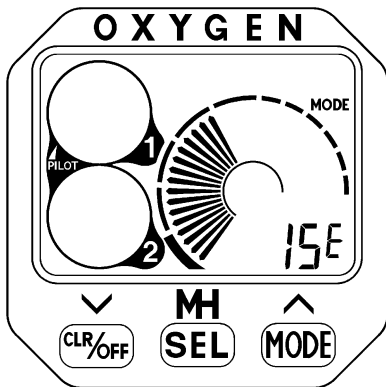
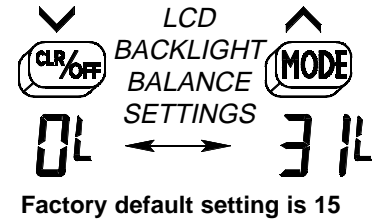

3- Adjusting the keypad backlight balance:

You can balance the brightness of the keypad back light in 32 increments with the overall panel independently of the other instruments. To do so, press & hold the **SEL** button and while doing so, and within ~2 seconds, press and release the **CLR/OFF** key. You will go directly to the LCD contrast adjustment menu. Press & release the **SEL** key twice to go to the desired KEY-Pad backlight balance setting. You can now increase the key-pad backlight with the **MODE** key and decrease the key-pad backlight with the **CLR/OFF** key. Notice that there are up and down symbols above these two outermost left & right keys to signify their function in this settings mode. *The keypad is lighted while the system is OFF.*

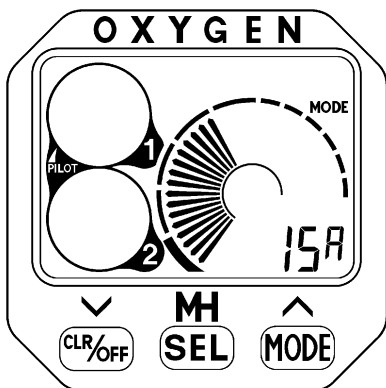
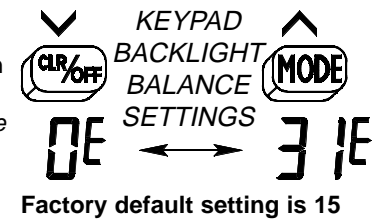

4- Adjusting the audio volume:

You can adjust the audio volume from silence (off) to full volume in 32 linear increments. To do so, press & hold the **SEL** button and while doing so (within a period of ~2 seconds) press and release the **CLR/OFF** key. You will go directly to the LCD contrast adjustment menu. Press & release the **SEL** key three more times to go to the desired Audio volume setting menu. You can then increase the audio volume with the **MODE** key and decrease the audio volume with the **CLR/OFF** key. You will notice that there is a down arrow over the **CLR/OFF** key and an up arrow over the **MODE** key. You can also glide up or down through the settings by pressing and holding down either the **MODE** or **CLR/OFF** keys.

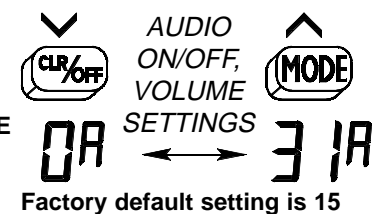

Customizing Station Settings (Refer to charts on page 9.)

Normally you will leave these at the default settings. They are, however, accessible for unique situations and applications. To do so, press & hold the **SEL** button and while doing so (within ~2 seconds) press and release the **MODE** key once to go directly to the settings menu for station one (1) or twice for the settings menu for station two (2). A third time will go to the control head settings menu, but you can cycle back to the station settings with more pressing of the **MODE** key. In fact, you can cycle through these menus in either direction with the **MODE** and **CLR/OFF** keys. Once at the desired station menu you can select one of four items unique to that station with the **SEL** key. At this point the **CLR/OFF** key reduces the setting and the **MODE** key increases the setting.

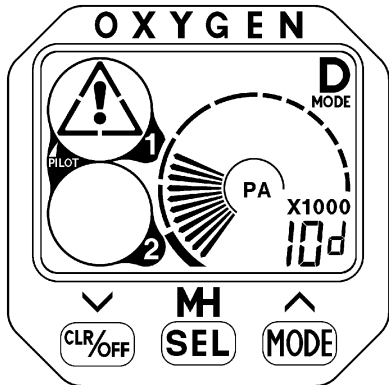

1- The D (Day or Delayed operations) trip-point settings:

You can select the point, in pressure altitude in 8 settings from 4 K ft. to 11 K ft. with the up & down buttons (**CLR/OFF** & **MODE**) where the station will wait to deliver oxygen until that pressure altitude and above have been detected by the control head. Stations not in use will only become active once they detect valid inspiration efforts.

The D mode is intended for day-time flight operations. In this mode, the station delays oxygen delivery until this preset pressure altitude is detected (set by the user) at which time, the system operates normally just as in the N mode.

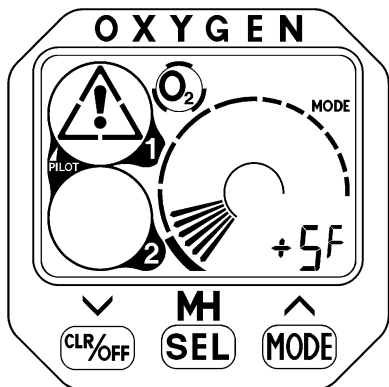
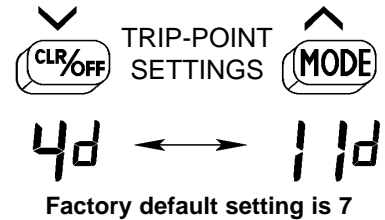

2- Setting oxygen delivery for face mask operations:

This setting is used to augment how the station delivers oxygen as a function of pressure altitude only while the system is in the A mode. There are 8 different curves (0 through +7) you can select. This will be necessary if a face mask is used for altitudes above 18,000 ft. Depending on the face mask and the person, settings from 2 to 4 will be normal. EDS face masks use a setting of 2.

The use of a pulse oximeter may be used to determine optimum settings in unique situations and applications. Smaller settings yield a less radical function curve. Larger settings yield a more radical function curve.

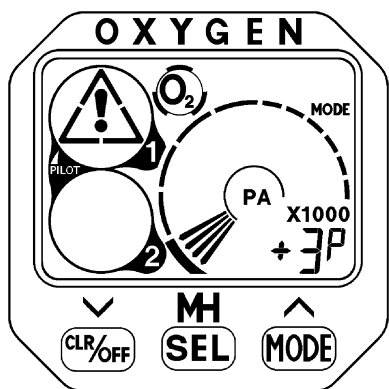
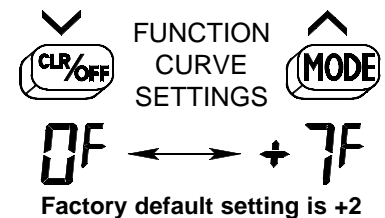

3- Setting the oxygen delivery profile (as a function of pressure altitude):

This setting allows you to change how much oxygen will be delivered as a function of pressure altitude. It is intended to allow you to compensate for those who may need more oxygen. There are eight (8) different curves (0 through +7) you can select. Each setting is ~12.5% more than the previous as a function of altitude. Once a pressure altitude of ~17.5 K ft. is detected, the unit will add the contents of the P curve to the contents of the F curve (P+F) for flight operations in class-A airspace suitable for compensating plenum area associated with face masks.

The use of a pulse oximeter may be used to determine optimum settings in unique situations and applications. Smaller settings yield a less radical function curve. Larger settings yield a more radical function curve.

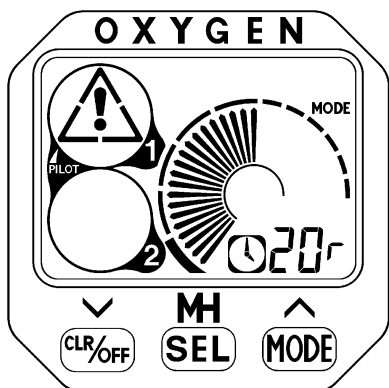
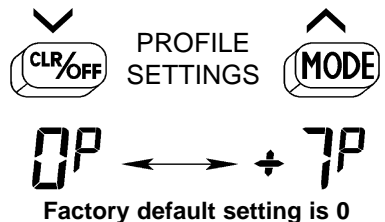

4- Setting 'R' respiration rate limit:

This setting allows you to adjust the maximum allowable respiration rate for that station. The range is 20 breaths per minute to 30 breaths per minute in eight (8) different steps defined as (20, 21, 22, 23, 24, 26, 28, 30). If you have a station set to allow 20 breaths per minute and you are actually breathing at say, 25 breaths per minute, the station will clip and allow (respond with) something less than your actual 25 breaths per minute. If clipping becomes an issue, you can make adjustments to accommodate this.

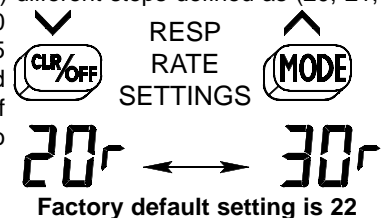

Oxygen Profile & Function Delivery Schedule and D Mode 'Trip-Point' Schedules

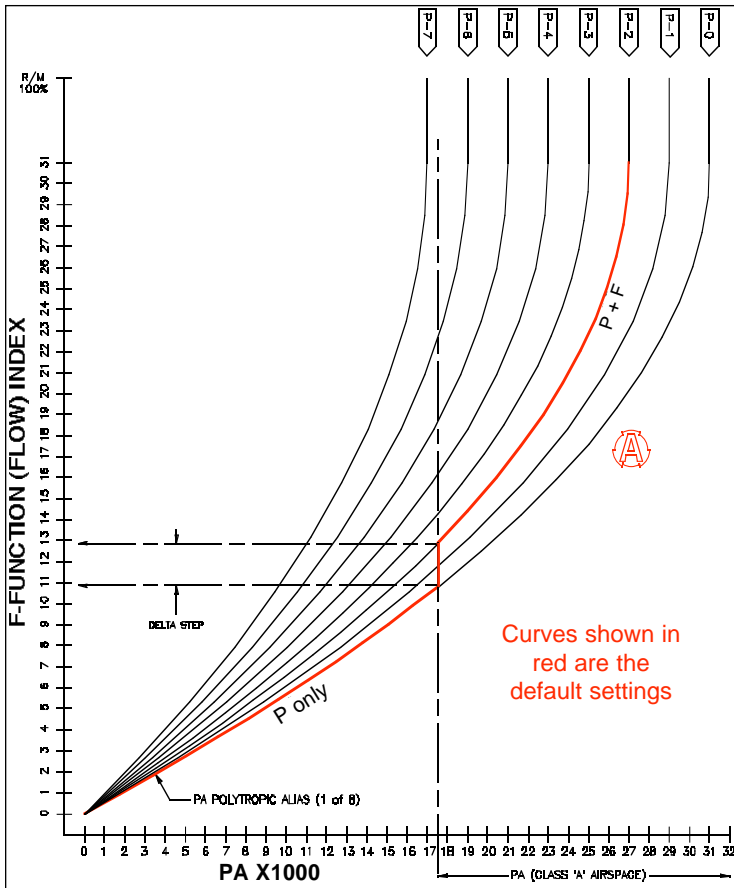

The EDS-ip system continuously monitors pressure altitude. Once a pressure altitude of ~ 17.5 K ft. is detected, it will automatically go into the 'A' mode and will display the 'A' icon indicating that it is operating in class-A airspace.

While operating below a pressure altitude for class-A airspace, the current 'P' curve setting is used to schedule oxygen out as a function of pressure altitude.

Once the unit is operating within the pressure altitude of class-A airspace the current 'P' curve settings and current 'F' settings are added together (P+F) to yield a richer flow schedule suitable for face mask operations.

The use of a pulse oximeter may be used to determine optimum settings in unique situations such as with persons who are elderly and/or are known to have respiratory issues.

Smaller settings yield a less aggressive curve (leaner with altitude).

Larger settings yield a more aggressive curve (richer with altitude).



**FlightStat
by NONIN**

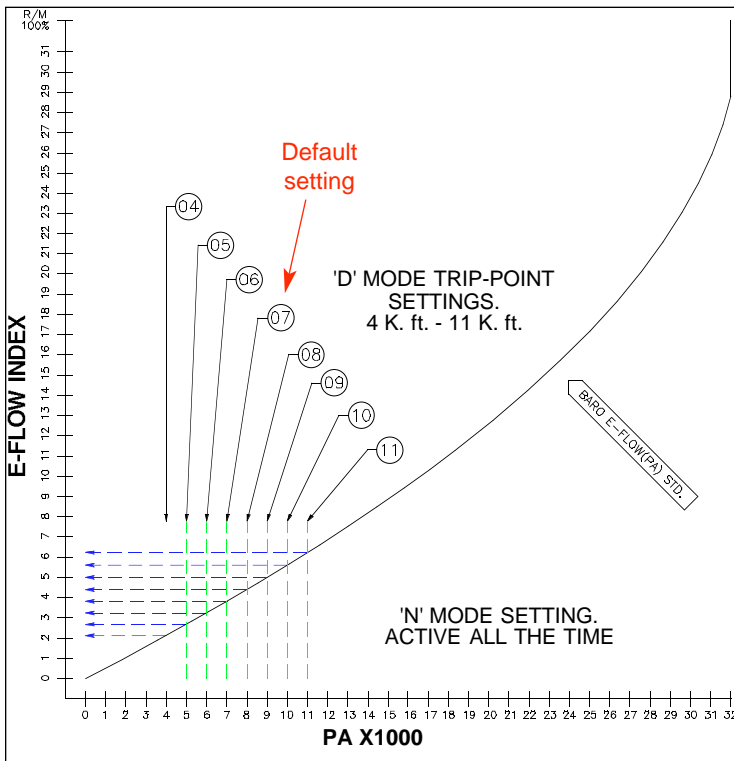

CheckMate by SPO

Restoring Settings to Factory Defaults

To restore the system settings to the factory defaults:

While the control head is in the **OFF** state press and hold the **CLR/OFF** button for about 3 seconds. Then, while still pressing the **CLR/OFF** button, press and release the **SEL** button. You will see that the **OFF** will change to **dEF** (for defaults). Now press and hold the **SEL** button. The unit will graphically display a counter-clockwise count-down sweep while doing this. Once the countdown is finished and none of the buttons have been released, the memory of the settings will be changed to the factory settings.

For the **control head** settings: **C**ontrast = 15, **B**ack**L**ight = 15, **kE**ys = 15, **A**udio = 15

For each of the **station** settings: **D**ay = 7, **F**acemask = 2, **P**rofile = 0, **r**espiration rate = 22

NOTE: If you should let the **CLR/OFF** button release at any time in this mode, the unit will go back to the **OFF** state without making any changes to the memory settings. Therefore, you must hold the **CLR/OFF** button down the entire time while doing this action. If you should press the **SEL** button twice and the display shows **CAL**, press and release it once more to get back to the **dEF** display.

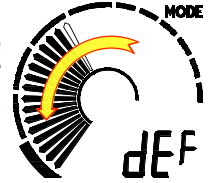

Calibrating the Pressure Sending Units

The tank and optional regulator pressure gauges operate electronically and are pre-calibrated, zeroed, with a 4 ma. standard at the factory and should work with almost any standard 4-20 ma. sending unit in the pressure range suitable for the display. Therefore, you should not need to perform this calibration in the field. However, if an electronic sending unit is replaced and shows an erroneous offset, calibration may be the solution.

A signal is sent from the sending unit in the form of DC current that corresponds to the pressure being sensed. That is, 4 ma. equals 0 (zero) and 20 ma. equals full scale pressure. Ranges are 0-3,000 psig for tank and 0-32 psig for regulator. A current below 4 ma with no pressure applied will constitute a faulty sending unit. No current measured at all will constitute a disconnected sending unit. In this case the graphical display will show nothing and the digital readout will simply respond with '- -'. However, with your initial installation if the gauge does not read at zero or simply shows '- -', the most likely reason would be from wiring errors.

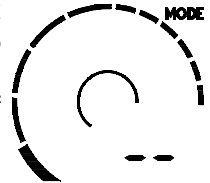

To zero / recalibrate the gauge inputs

This procedure will attempt to calibrate (zero) both gauge inputs. Make sure that you have either a 4 ma. current standard connected into each gauge input or have a set of good known pressure sending units connected. **Make sure that there is no pressure being applied to any of the sending units during this procedure.**

While the control head is in the **OFF** state, press and hold the **CLR/OFF** button for about 3 seconds. Then, while still holding the **CLR/OFF** button down, press and release the **SEL** button twice. You will see that the **OFF** will change to **dEF** (for defaults) then **CAL** (for calibrate). The **SEL** button toggles between the two.

To calibrate the gauge inputs, press and hold down the **SEL** button while **CAL** is displayed. The unit will graphically display a counter-clockwise count-down sweep while doing the calibration. If the **CLR/OFF** button has not been released, during the countdown, the control head will be calibrated from the 4 ma. input from the sending unit as zero and will be stored into flash memory. The unit will then go back to the **OFF** state if both inputs calibrated successfully.

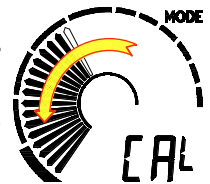

NOTE: If you should release the **CLR/OFF** button at any time in this mode, the unit will go back to the **OFF** state without recalibrating. Therefore, you must hold the **CLR/OFF** button down until the countdown sweep has completed.

NOTE: If there is not a 4 ma. standard present or if the input current is under or over a certain range for the gauge inputs during this procedure, it will reject that input calibration process and the original setting will be used for the zero offset. In addition, a calibration reject code will be displayed rather than the **OFF** message to inform you that you do not have the correct input current standard (4 ma.). The calibration reject codes are: **Cr1** = gauge input one (1) was rejected, **Cr2** = gauge input two (2) was rejected, **Cr3** = both gauge inputs one & two (1 & 2) was rejected. This code message will be displayed until you release either the **CLR/OFF** or **SEL** button.

NOTE: In standard configurations only the tank pressure transducer is used. Therefore, you will always see **Cr1** after every calibration command. This is because nothing is normally connected to gauge input one (the optional regulator pressure monitor) and that input will always be rejected from the calibrate command.



EDS Cannula (standard issue)



Cannulas supplied with the EDS-ip systems are specifically selected to operate with the EDS-ip system. They complement the physiological needs of a person for flight operations from sea level to the edge of class-A airspace, 18,000 ft. The EDS cannulas are silicone molded with a 1 meter length of high quality PVC tubing and fitting. They fit to the face with a set of over-the-ear feed tubes to accommodate almost any face. Beards and mustaches will not compromise the delivery properties of cannulas in general. However, even

the slightest amount of nasal congestion can. Therefore, it is advisable that a face mask be used in the event of such problem.

In most cases the standard-tip cannula suits the needs of most people, while the flare-tip type may be needed to fit a large person or one that has large nasal openings. Standard-tip cannulas are issued by default unless otherwise stated at time of purchase.

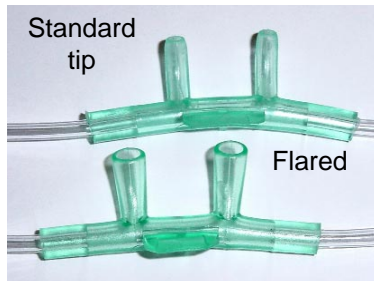

The EDS cannula is a personal device and should not be shared between persons. In addition, it is the only item in the system that should be replaced frequently, because even with the best cleaning efforts, bacteria and such can contaminate the cannula and pose a health risk.

Optional Head-Set Boom Mounted Cannula



MH OxyArm
Boom Cannula is a head-set mountable cannula system that can be used with the EDS-ip system.



EDS Face Masks (standard issue)

The standard issue EDS face masks supplied with the EDS-ip systems are specifically selected to operate with the EDS-ip system. They complement the physiological needs for flight operations from sea level through pressure altitudes up to 25,000 ft. However, if flight operations are frequent at these altitudes, one should consider using the **Deluxe** EDS face mask. They are supplied with a 1 meter length of high quality PVC tubing and fitting.

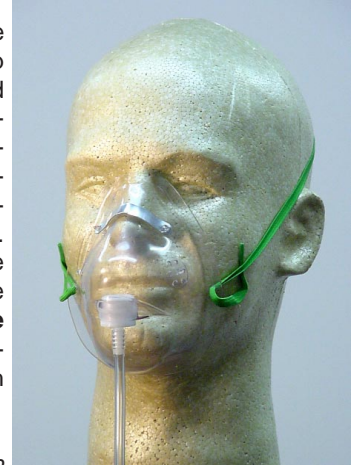

Face mask should be on board in the event someone should develop nasal congestion where a nasal cannula would fall short in performance.

Optional Equipment

Alps EDS Face Mask (with or without microphone)

Oxygen admission port with swivel quick disconnect fitting
 Oxygen feed-tube to distributor unit

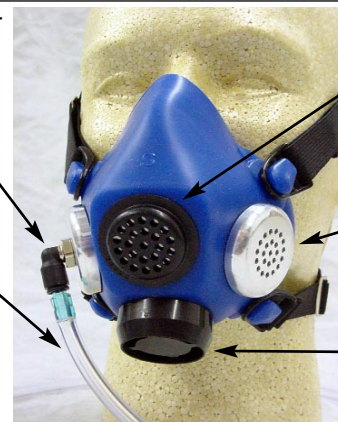

Voice port or optional Microphone
 Ambient air admission port
 Expiratory valve port

The **Alps** EDS face mask is specifically designed to operate with the EDS-ip system. They complement the physiological needs of a person for flight operations from sea level through pressure altitudes up to 25,000 ft. They have a four-point detachable clip system with two independently adjustable straps to accommodate almost any face. Beards and mustaches will compromise the sealing properties of face masks in general. These face masks can be cleaned with mild detergents and water.

The **Alps** EDS face masks have a voice-port so vocal communication is possible without mask removal. The microphone of a head-set can be placed close to the voice-port and used with satisfactory results. The **Alps** EDS face mask can be ordered with an optional noise canceling electret-condenser microphone & cord set compatible with most com & audio systems in place of the voice port. Please specify during ordering.



One **Alps** EDS face mask (for the pilot) comes with each IP system. It comes in three sizes: medium, small and large. In most cases the medium and small fit most women, while the medium and large fit most men. The medium size face mask is issued by default unless otherwise stated at time of purchase.

Oxygen Distributor (Station Outlets) Description & Operation

The oxygen distributor units have a red 'push-to-test' button, a tricolor light behind the O₂ logo and an oxygen outlet connector. The button is mainly used as a test-for-readiness, but because it will also emit a 1 second blast of oxygen it can be used as a 'I want O₂ now!' button for those who desire such. Each time the red button is pressed the control head will display a ! in the corresponding station's status circle. The O₂ Distributor unit will pass a 1 second blast of oxygen. However, if the button is pressed & held down the O₂ Distributor unit will pass oxygen only once. The button has to be released for at least 3 seconds before the station unit will respond with oxygen again.

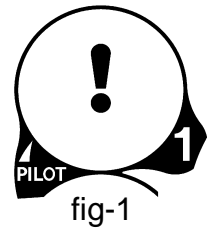

fig-1

The tricolor LED (fig-2) behind the O₂ logo on each O₂ Distributor unit will light green for each positive inspiration response. It has been determined that the O₂ Distributor unit should not emit light during night-time operations unless there is a good reason. Therefore, the green light will not light from positive flow responses if the control head has detected a lights on condition. Flow-Faults will light the red LED and Apnea conditions will light the yellow LED, in a much reduced brightness factor so that it would not be disruptive in a darkened cabin.



fig-2

The static port labeled 'DO NOT COVER' on each O₂ Distributor unit must be vented directly and without any obstruction into the cabin. The rest of the unit is pneumatically insulated so that you have the freedom to install it into various situations, including vent ducts. It is very important that the front of the station with the static port not have any air blow directly into or across it. The oxygen outlet connector on each station is a bayonet twist-lock type. Stations not in use will emit a blast of oxygen once for each time the system is first turned on. It will not pass O₂ at any other time unless a cannula or face mask is connected and a person is breathing.

NOTE:
If no one is using a station when the system is first turned on, it will default to an active mode and display apnea once an active pressure altitude is detected. This can be cleared by pressing and releasing the **CLR/OFF** button.

The green LEDs on each station oxygen distributor unit will not light while the panel lights are on. This is necessary to keep the distributor units from acting as an annoyance during night operations. The Red and Amber LED will light if triggered, however, at a much lower level. All LEDs will resume to their normal mode and brightness while aircraft panel lights are off.

Description of DE-09 connector pins on the OXYGEN DISTRIBUTOR units:

- 01: Shield / Ground. Connected to enclosure of DIST unit.
- 02: System ground return for power & communications.
- 03: +10 VDC input supply with respect to ground.
- 04: Data from control head
- 05: Data to control head
- 06, 07, 08, 09: Diagnostic connections. DO NOT USE THESE!

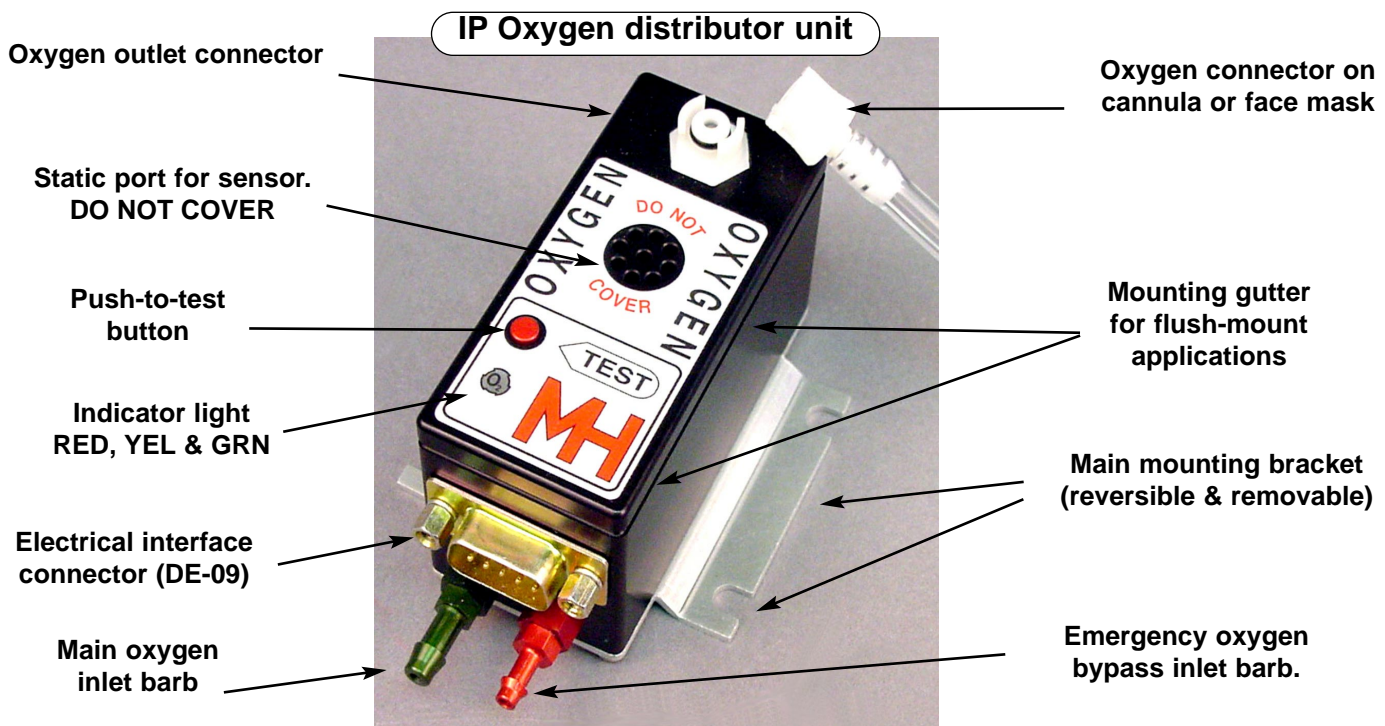
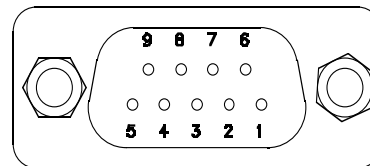

1

2

3

4

REVISION HISTORY (version roll-offs are kept onfile)

REV	MO-DA-YR	NEO / ECO	NAME	NOTES
-	05-19-04			INITIAL DRAFT
A	10-10-10			CORRECTED SMALL TEXT ERRORS

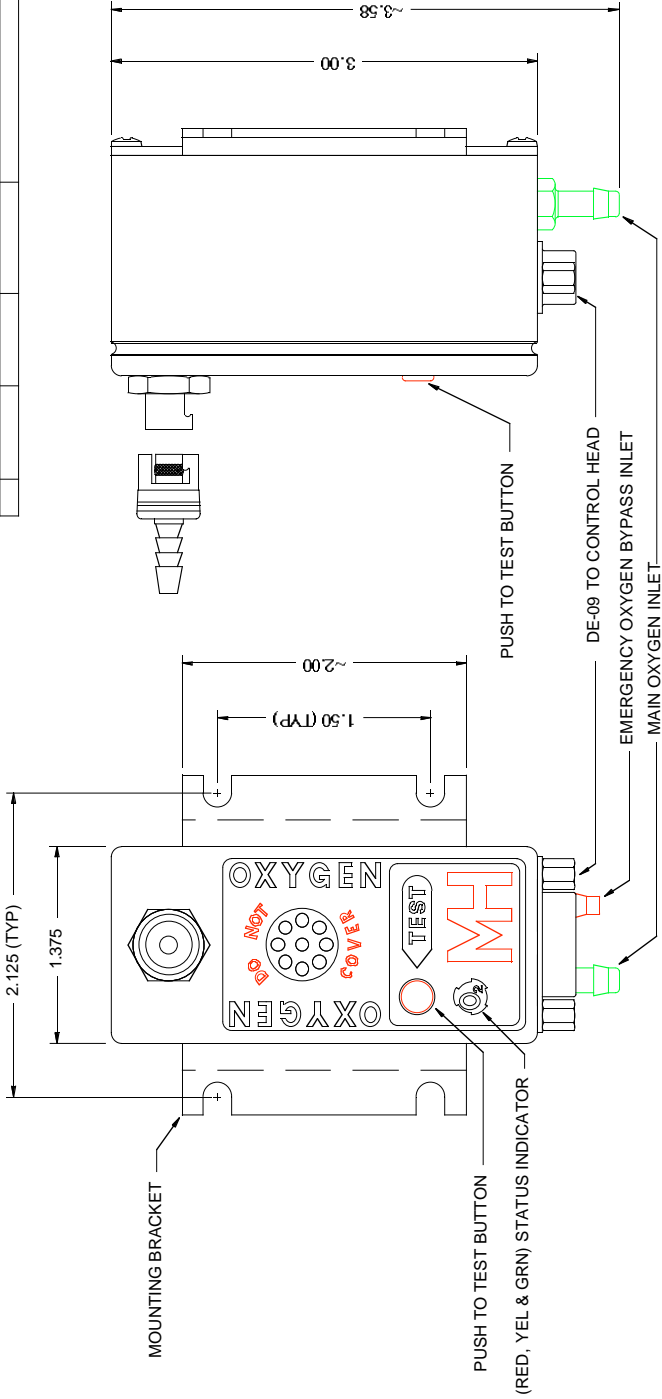

PIN	PIN FUNCTION
1	SHIELD / CASE GROUND
2	GROUND POWER & SIGNAL RETURN TO CONTROL HEAD
3	+10 VDC POWER SUPPLY INPUT FROM CONTROL HEAD
4	DATA INPUT: Rx FROM CONTROL HEAD (IP-232 DC LEVELS)
5	DATA OUTPUT: Tx TO CONTROL HEAD (IP-232 DC LEVELS)
6	
7	
8	
9	

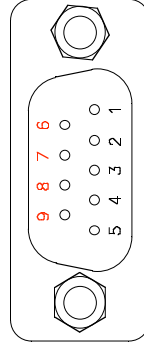

OUTLET TO CANNULA / FACE MASK

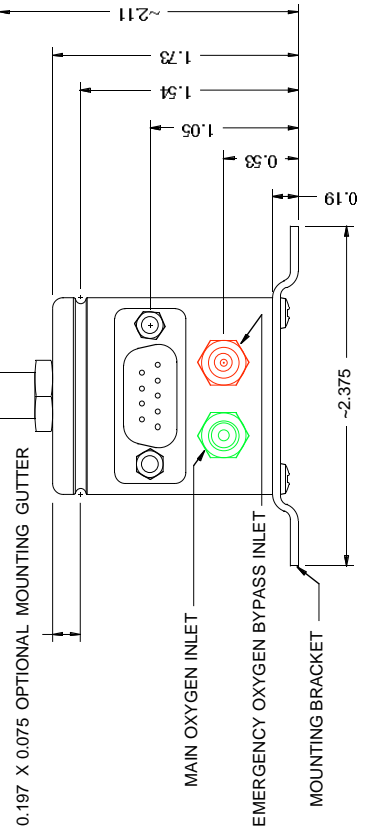

UNLESS OTHERWISE SPECIFIED DIMS ARE IN INCHES.

0.X	±0.015	ANGLES	FRACTIONS	63
0.XX	±0.010			± 1/64
0.XXX	±0.005			

INTERPRET	GD&T	PER ASME 14.5	FMT	REV H
DESIGN	MODA-YR	PLM, 01-02-07	A	
ENGINEER	MODA-YR	PLM, 01-02-07	A	
DRAWN	MODA-YR	PLM, 01-02-07	A	
CHECKED	MODA-YR			
DATE				



MOUNTAIN HIGH E&S CO. REDMOND, OR. USA

[KC]	NUMBER OF KEY CHARACTERISTICS IN THIS DRAWING / DOCUMENT PER MH DOC: ESR-001	00
EDS-IP	DIST UNIT	FORM-FACTOR DETAIL
EDSIP-051-004	DWG. REVISION	REV A
EDS-ip	Install Schematics	1 OF 1
ADIST-0100-00	DWG. SHEETS	1 OF 1
ADIST-0100-00	DWG. NUMBER	ADIST-0100-00

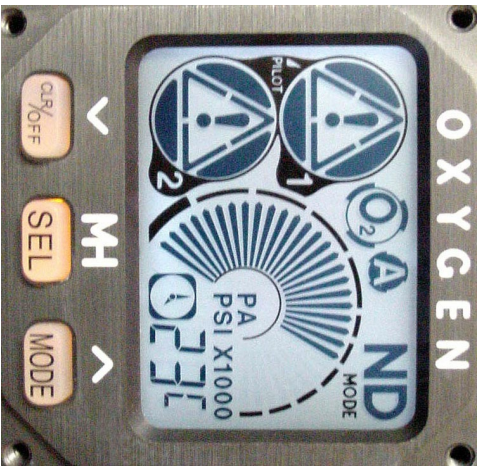
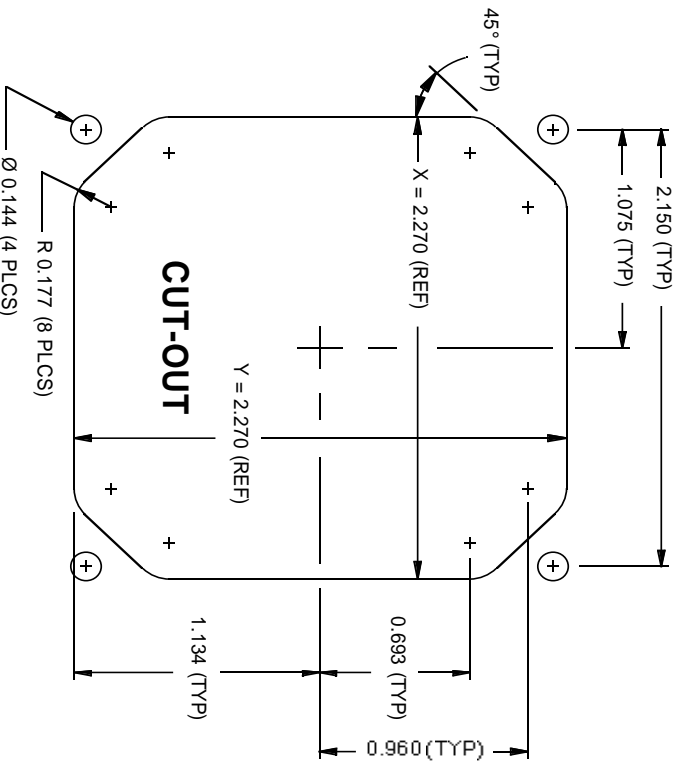
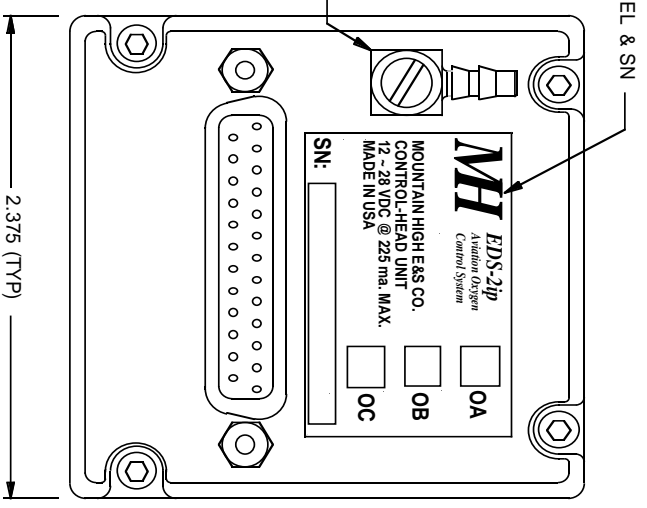
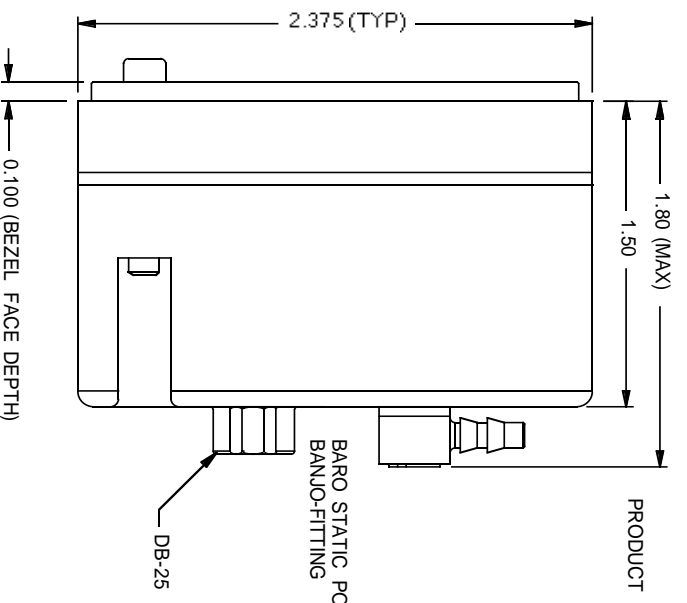
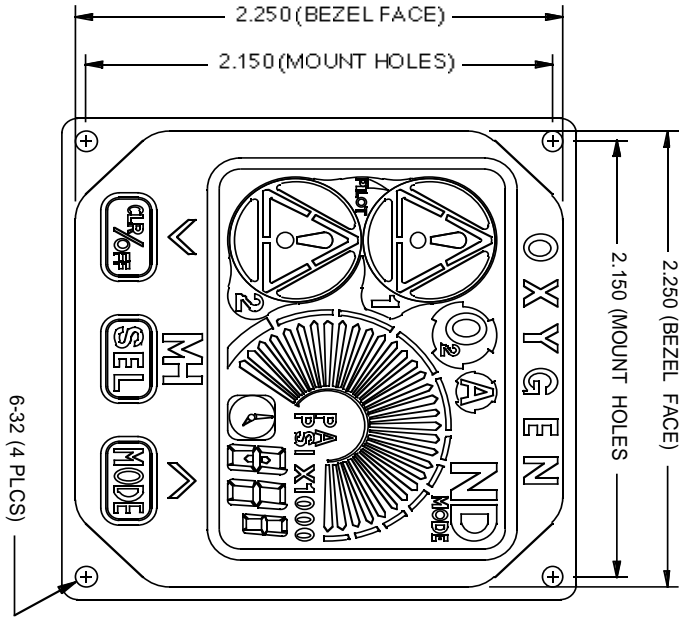

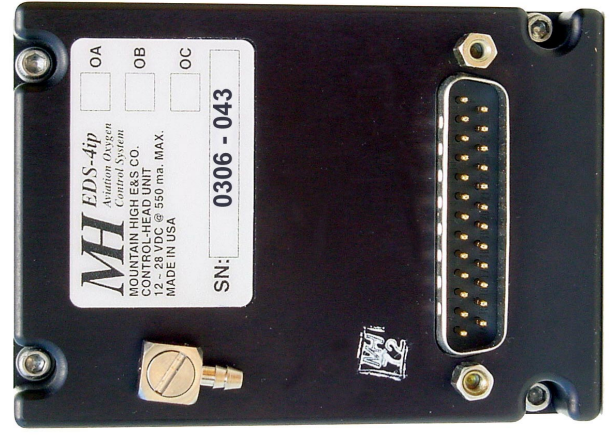
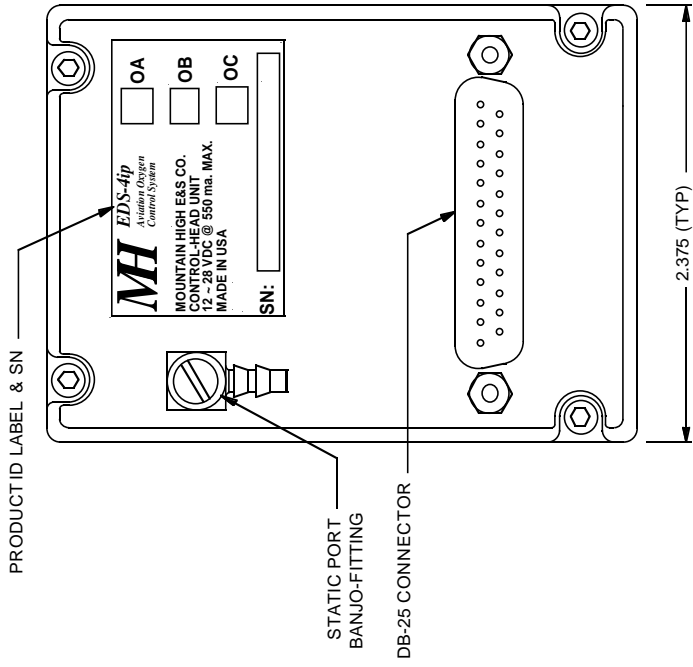
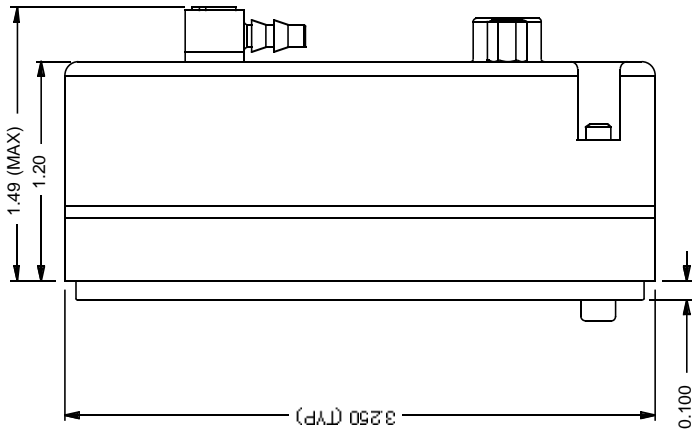
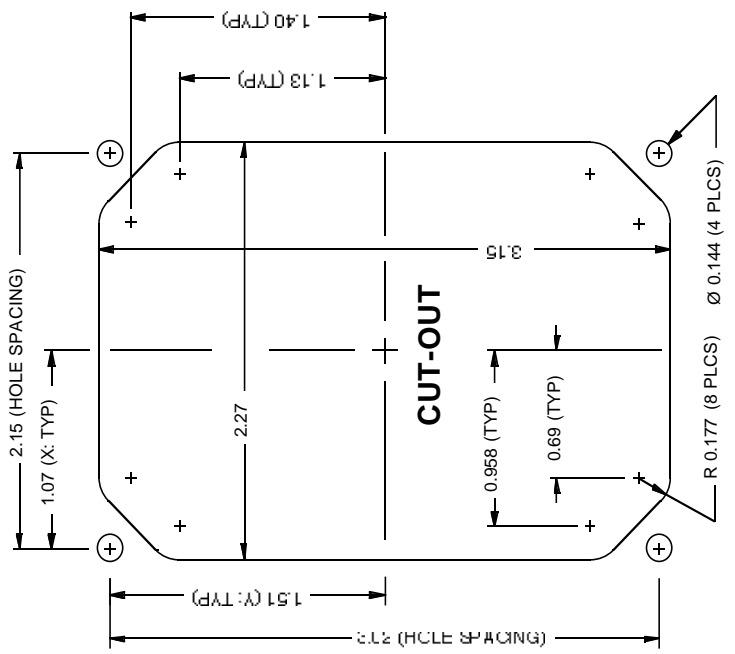
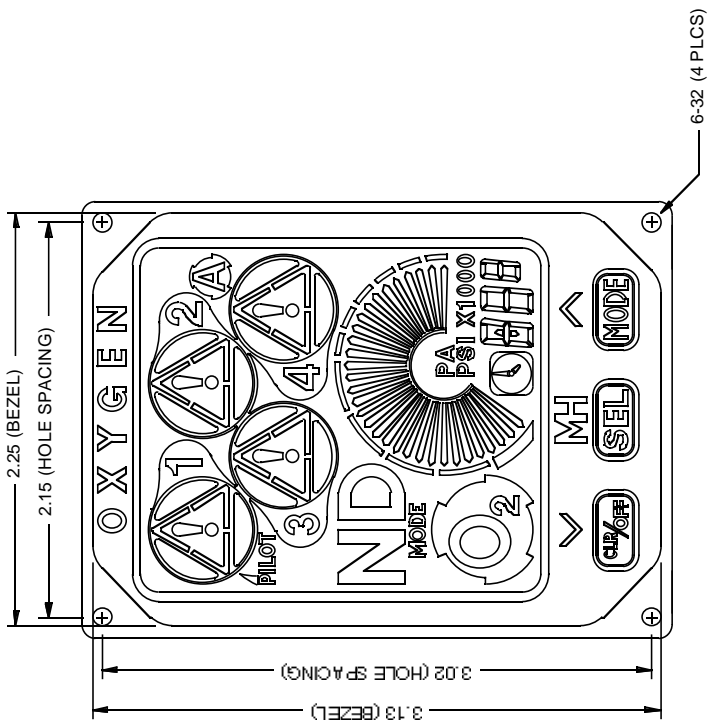

Basic IPR Components & Suggested Installation Layouts

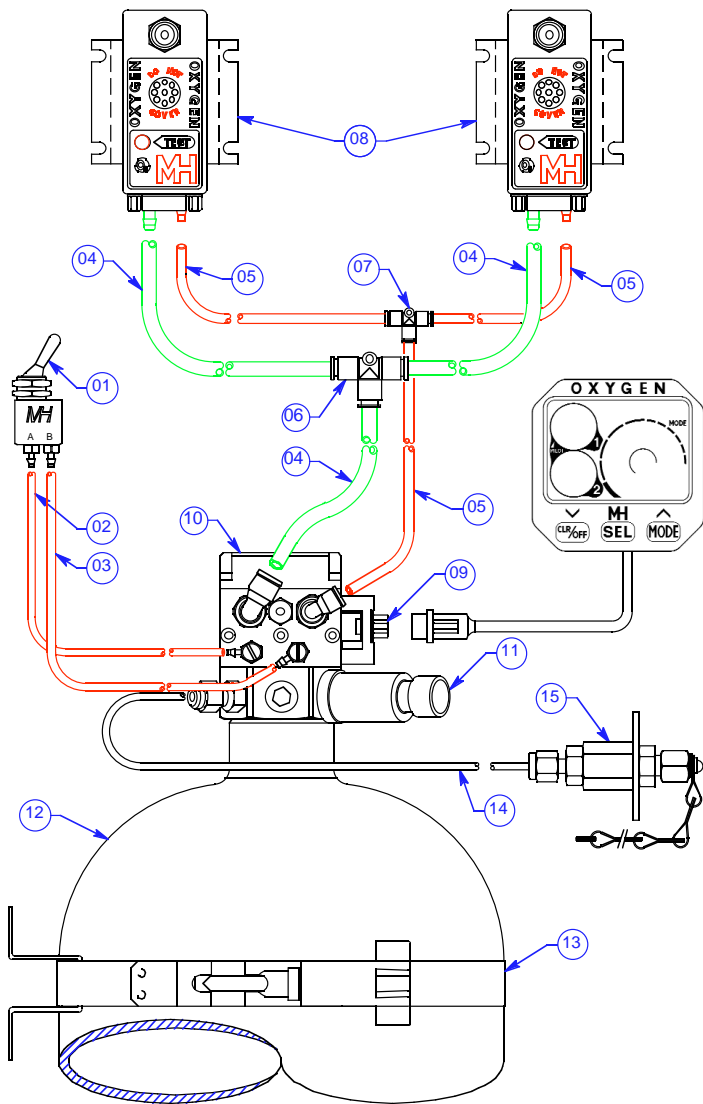

Shown here is a typical installation method with polyurethane lines suitable for experimental built high-performance aircraft.

- 01: Emergency O2 bypass control switch
- 02: Emergency O2 bypass port 'A' 3 mm. Orange tubing
- 03: Emergency O2 bypass port 'B' 3 mm. Yellow tubing
- 04: Main O2 polyurethane tubing 6 mm. OD
- 05: Emergency O2 polyurethane tubing 4 mm. OD
- 06: 'Tee' union for 6 mm polyurethane tubing
- 07: 'Tee' union for 4 mm polyurethane tubing
- 08: Electronic Oxygen delivery unit 'Distributor'
- 09: Connector to IP control head (DE-09)
- 10: IPR regulator Assy.
- 11: Electronic pressure sending unit (4-20 ma. type)
- 12: Oxygen Tank / Cylinder
- 13: Tank / Cylinder mounting / Hold-Down kit
- 14: 1/8" OD HP copper line to fill station Assy.
- 15: Oxygen fill station Assy. (others available by option)

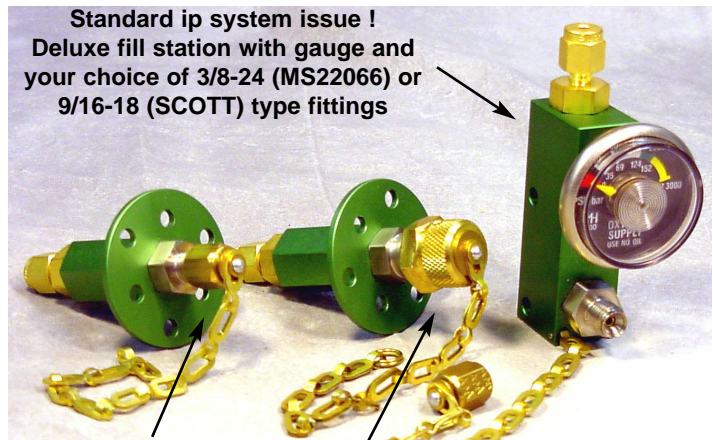

Optional oxygen fill station 3/8-24 (MS22066)

Or optional 9/16-18 (SCOTT) fitting

To ensure the proper flow of oxygen while the cylinders become low (~800 psig and below) it is very important that 3/16" Diameter tube be used between the IPR regulator and cylinder if it is to be remotely mounted. This applies to remotely coupling cylinders as well. The fill station can be plumbed with 1/8" OD tubing.

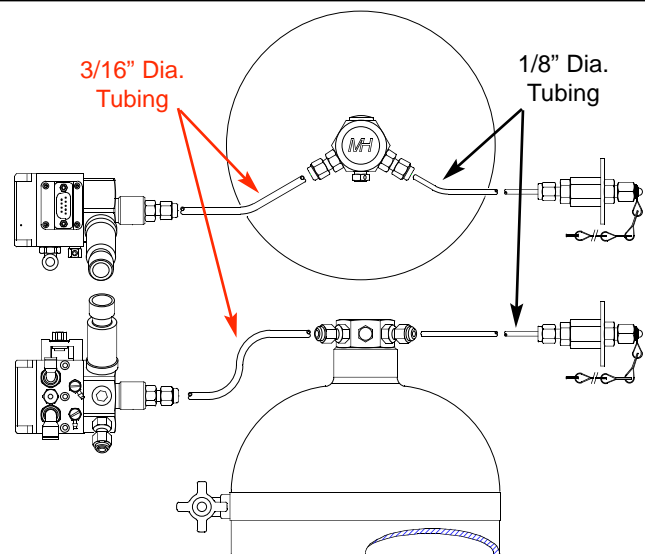
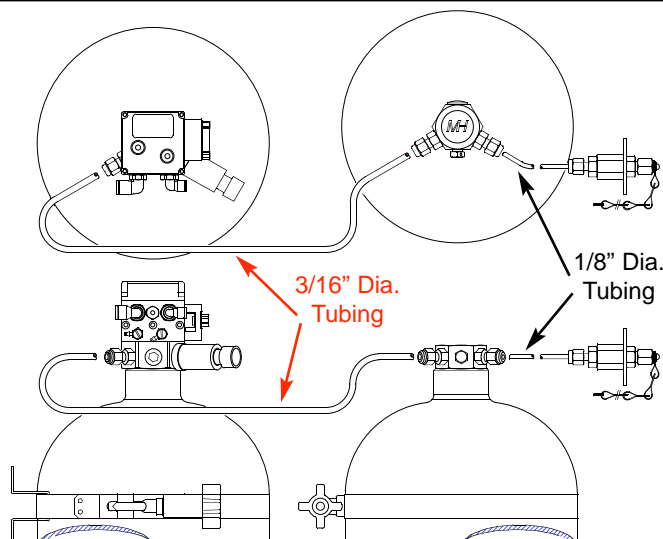

Basic IPR Components & Suggested Installation Layouts

Shown here is an alternate, future, installation method with hard-lines. A manifold kit is used with the IPR and DIST units that allow for easy installation and removal of the IPR and DIST units for hydro-testing and periodic maintenance.

- 01: DIST unit with fittings
- 02: Transition Manifold for DIST units
- 03: SAE-3 to flare 1/4" O.D. Alum. tube fitting for main O₂ line
- 04: SAE-3 to flare 3/16" O.D. Alum. tube fitting for emergency O₂ bypass circuit
- 05: 1/4" O.D. Alum. tubing (Main Low pressure O₂ line)
- 06: 3/16" O.D. Alum. tubing (Emergency Bypass Low pressure O₂ line)
- 07: 'Tee' fitting 1/4" O.D. Alum. tube
- 08: 'Tee' fitting 3/16" O.D. Alum. tube
- 09: Adel clamp for 1/4" O.D. Alum. tube
- 10: Adel clamp for 5/32" O.D. Alum. tube
- 11: IPR transition manifold kit
- 12: IPR regulator Assy.
- 13: 1/16" O.D. copper tubing (part of bypass switch & tubing kit)
- 14: 1/16" O.D. compression-type tube fitting (part of bypass switch & tubing kit)
- 15: Emergency O₂ bypass control switch (part of bypass switch & tubing kit)

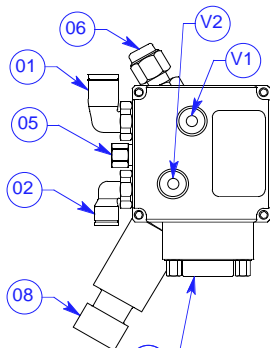
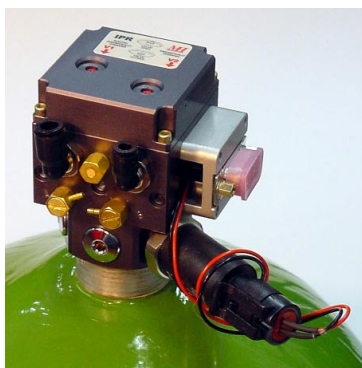
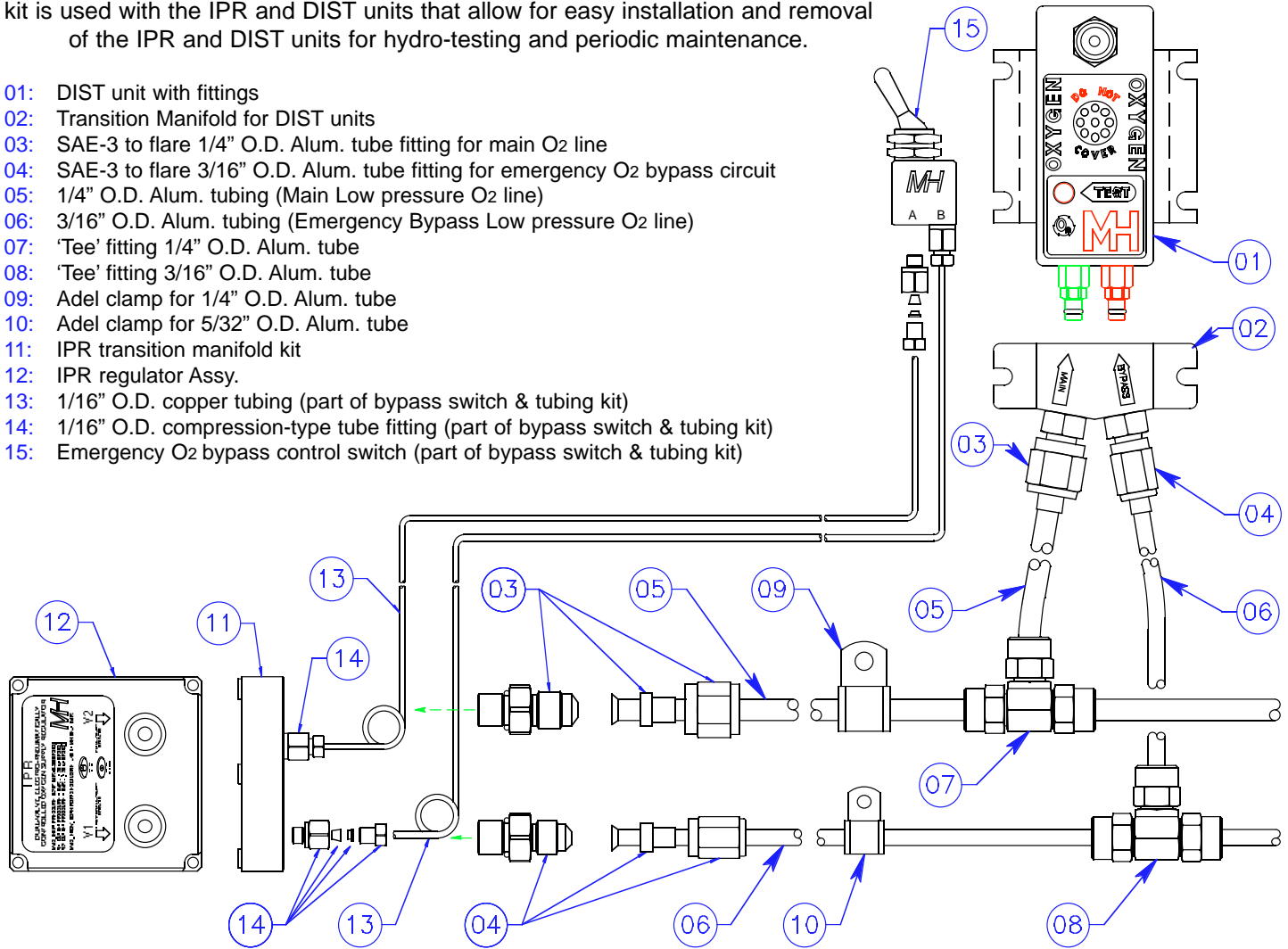

Shown here is a detail of the IPR regulator assembly. Fittings are all O-ring type SAE and BSPP to mitigate leakage and allow for easy installation and removal. The main threads on the IPR regulator are 3/4-16 (SAE-8) that also allow removal of the IPR regulator for hydro-testing and maintenance without thread damage as it would be with regulators with NPT threads.

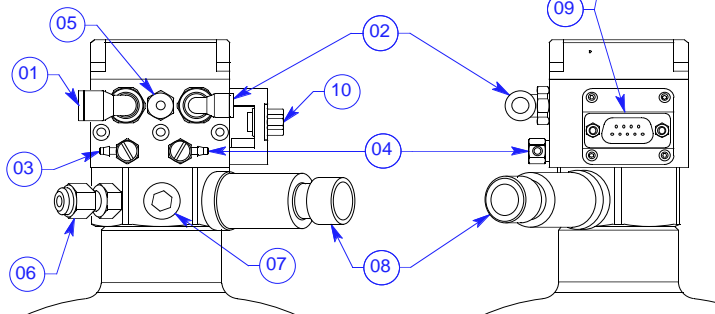

- 01: Main O₂ outlet swivel-elbow fitting (6 mm.)
- 02: Emergency O₂ bypass outlet swivel-elbow fitting (4 mm.)
- 03: Emergency O₂ bypass control port 'A' to switch port 'A'
- 04: Emergency O₂ bypass control port 'B' to switch port 'B'
- 05: Ambient port muffer / filter
- 06: HP SAE-4 to 1/8" OD tube fitting for fill station
- 07: HP SAE-4 plug (2 ea.)
- 08: Electronic pressure sending unit (4-20 ma.)
- 09: Electrical interface connector DE-09

- V1: Main oxygen valve pop-up indicator
- V2: Emergency O₂ bypass valve pop-up indicator

REVISION HISTORY			
REV	DATE	E. C. O. / APPR.	NOTES
-	03-03-03	PLM	INITIAL RELEASEE

- ELECTRICAL
- 1 bar (15 PSIG.) OXYGEN, REGULATED
- 1 bar (15 PSIG.) STATIC PNEUMATIC SIGNAL, REGULATED

OXYGEN DISTRIBUTOR CONTROL & DISPLAY HEAD

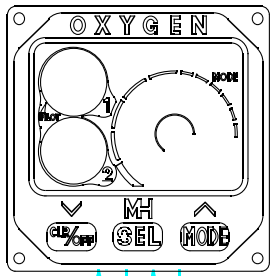

ELECTRICAL & SYSTEMS INTERFACE WITH AIRCRAFT

OXYGEN DISTRIBUTOR OUTLET STATION -1

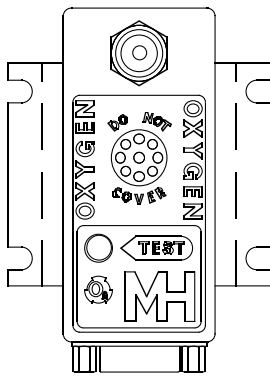

OXYGEN DISTRIBUTOR OUTLET STATION -2

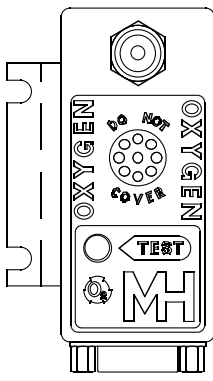

EMERGENCY OXYGEN



NORM

10

01

02

03

04

05

06

06

03

08

RCRip WITH OXYGEN TANK

FILL STATION (MS22035/66)

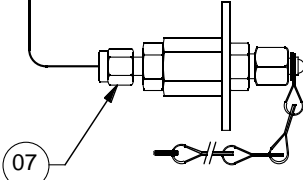

07

REF	DESCRIPTION
01	DB-25 CONNECTOR & CABLES
02	INTERFACE WITH AIRCRAFT
03	CONNECTION TO DIST UNITS
04	CONNECTION TO RCV/RCR ASSY.
05	REGULATED OXYGEN @ 1 bar
06	IPR REGULATOR ASSY.
07	FILLER STATION & HP LINE
08	BYPASS OXYGEN CONTROL @ 1 bar
09	BYPASS OXYGEN FEED @ 1 bar
10	BYPASS OXYGEN SWITCH

UNLESS OTHERWISE SPECIFIED DIMS ARE IN INCHES.		THIRD ANGLE PROJECTION.	<CR> KEY CHARACTERISTICS	QTY
TOLERANCES ARE:		ANGLES	<MA> PER CORP. DOC: ESR-001	
0.X	±0.010	FRACTIONS	MOUNTAIN HIGH	
0.XX	±0.005	± 0.5°	E&S CO.	
0.XXX	±0.002	± 1/64	REDMOND, OR. USA	
INTERPRET GOVT PER ASME 14.5 (FMT REV A)				
ISSUED:	DATE	EDS 2IP SIMPLE SCHEMATIC		
DRAWN: PLM	03-03-03	DWG. #: N Y A		REV -
ENGINEER: PLM	DATE	SIZE A	SHEET 1 OF 1	DO NOT SCALE DRAWING
APPR:	DATE			

1

2

3

4

REVISION HISTORY

REV	DA-MO-YR	E. C. O. / APPR.	NOTES
-	06-19-04	PLM	INITIAL RELEASE
A	09-15-05	PLM	MOVED ORIFICE FROM PORT 2 TO PORT 3 OF THE VK
B	02-03-06	PLM	CORRECTED REVERSED VK & PRESS UNIT ASSIGNMENTS

FRONT-VIEW OF DE-09

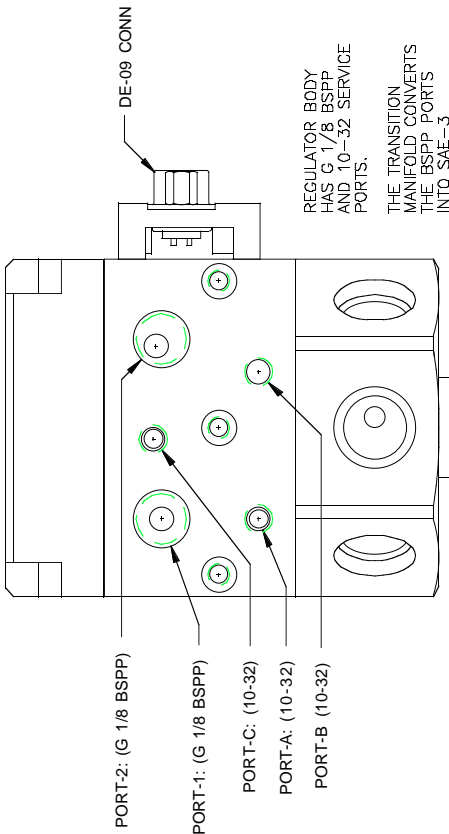
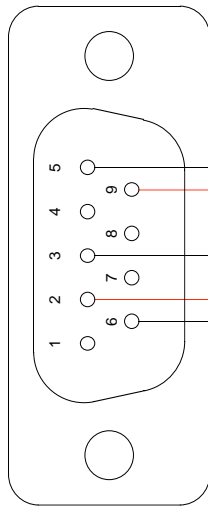

REGULATOR BODY HAS G 1/8 BSPP AND 10-32 SERVICE PORTS.

THE TRANSITION MANIFOLD CONVERTS THE BSPP PORTS INTO SAE-3

DIODE IS OPTIONAL

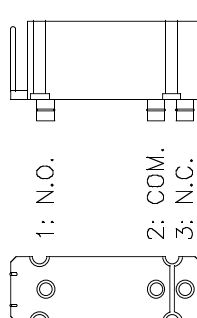
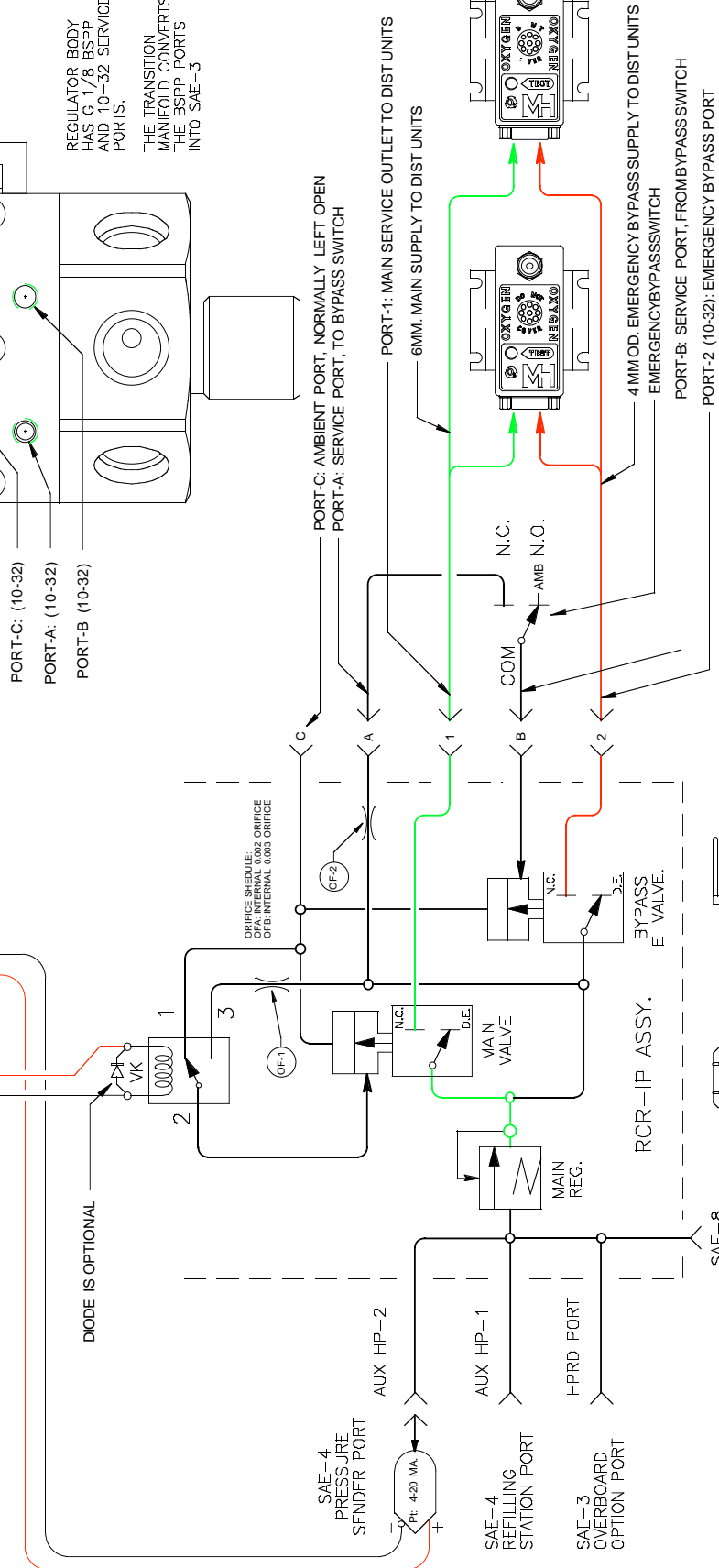

SAE-8 (COAXIAL-4) MAIN INLET PORT (CYLINDER)

THIS DOCUMENT AND ALL TECHNICAL DATA HEREIN DISCLOSED ARE PROPERTY OF THE U.S. GOVERNMENT AND ARE TO BE USED WITHOUT WRITTEN PERMISSION FROM THE U.S. GOVERNMENT. THIS DOCUMENT MUST BE RETURNED TO THE U.S. GOVERNMENT IMMEDIATELY UPON REQUEST.

UNLESS OTHERWISE SPECIFIED DIMS ARE IN INCHES.	THIRD ANGLE PROJECTION	[KC] NUMBER OF KEY CHARACTERISTICS IN THIS DRAWING / DOCUMENT PER WH DOC: ESR-001
0.X ±0.010	ANGLES ±0.5°	63
0.XX ±0.005	FRACTIONS ±1/64	
0.XXX ±0.002	PER ASME 14.5	(FMT REV C)

ISSUED:	DATE	SCHEMATIC IPR
INTERPRET GDBT	05-19-04	MH
DRAWN:	05-19-04	
ENGINEER:	05-19-04	
APPR:		

DWG. #:	SIZE	SHEET 1 OF 1	REV B
EDSIP-051-005	A	1	

REVISION HISTORY		
REV	DESCRIPTION	DATE
0		
1		
2	ADDED DETAIL FOR TANK PRESSURE SENDING UNIT	25-09-07
3	RESTORED ORIGINAL DWG NUMBER SYSTEM FOR THESE SHEETS	03-06-08
4	CORRECTED AUDIO OUTPUT SPECIFICATIONS	17-12-08
5		
6		
7		
8		

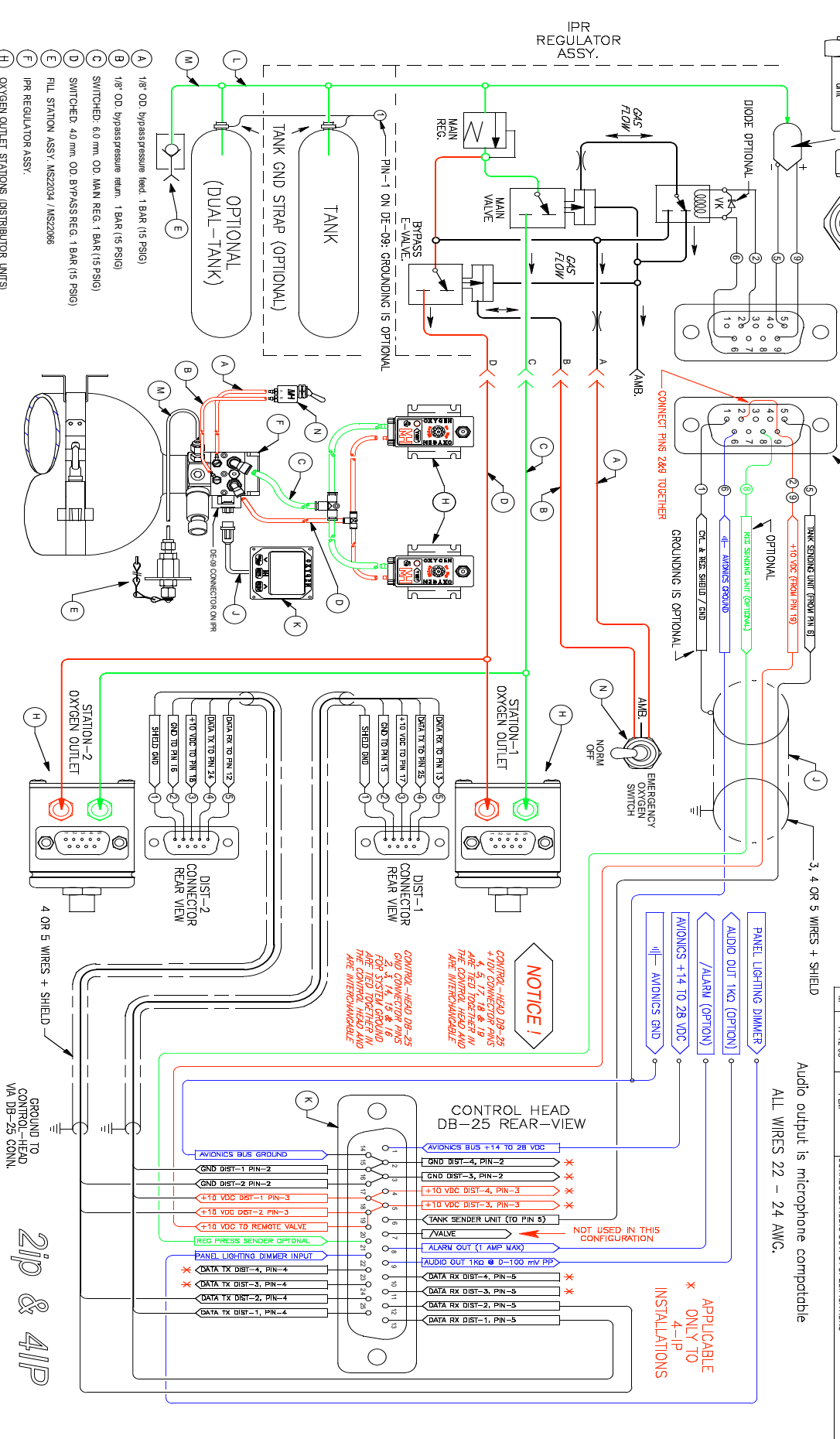

EDS 2ip & 4IP ELECTRICAL-PNEUMATIC IPR SCHEMATIC

THIRD ANGLE PROJECTION

IP ELECTRO-PNEUMATIC SCHEMATIC

ORIG. PNM	10-11-00	REV M
DRWN. PNM	10-11-00	REV M
ENG. PNM	10-11-00	REV M
APPR. NAME	DAMO-IR	REV M

DWG # EDSIP-051-000

SIZE B SHEET 1 OF 1

- LEGEND:**
- A: 1/8" OD. Bypass pressure return. 1 BAR (15 PSIG)
 - B: 1/8" OD. Bypass pressure return. 1 BAR (15 PSIG)
 - C: SWITCHED. 6.0 mm. OD. MAIN REG. 1 BAR (15 PSIG)
 - D: SWITCHED. 4.0 mm. OD. BYPASS REG. 1 BAR (15 PSIG)
 - E: FILL STATION ASSY. MS22034 / MS22065
 - F: IPR REGULATOR ASSY.
 - G: OXYGEN OUTLET STATIONS (DISTRIBUTOR UNITS)
 - H: IPR TO CONTROL HEAD ELECTRICAL INTERCONNECT
 - I: CONTROL HEAD UNIT (2P SHOWN)
 - J: 3/16" OD. COPPER, ALUM. OR STAINLESS TUBING F REMOTE
 - K: 1/8" OD. COPPER, ALUM. OR STAINLESS TUBING
 - L: EMERGENCY OXYGEN BYPASS PNEUMATIC SWITCH
 - M: TANK PSU OUTPUT -
 - N: REMOTE VALVE ENABLE GND
 - O: TANK GND STRAP (OPTIONAL)
 - P: TANK PSU OUTPUT -
 - Q: TANK GND STRAP (OPTIONAL)
 - R: TANK PSU OUTPUT -
 - S: TANK GND STRAP (OPTIONAL)
 - T: TANK PSU OUTPUT -

IPR

REVISION HISTORY

REV	DRAWN	E.C.O./APPR.	NOTES
-	02-09-05	PLM	INITIAL DRAFT
K	02-11-06	PLM	EXPANDED NUMBER OF DRAWING SHEETS
L	03-06-08	PLM	RESTORED ORIGINAL DWG. NUMBER SYSTEM FOR THESE SHEETS

REF	QTY	DESCRIPTION
01	01	MAIN ELECTRICAL SYSTEM INTERFACE WITH AIRCRAFT
02	01	MULTI CONDUCTOR SHIELDED CABLE TO AIRCRAFT & CONTROL HEAD INTERFACE
03	01	HARNESS ASSY. DB-25 CONNECTOR TO CONTROL HEAD
04	01	ELECTRICAL INTERFACE DB-25 CONNECTOR ON CONTROL HEAD
05	01	CABIN PRESSURE (BARO) INTERFACE CONNECTOR ON CONTROL HEAD
06	01	IP SYSTEM CONTROL HEAD ASSEMBLY
07	01	PNEUMATIC EMERGENCY OXYGEN (FULL-FLOW) BYPASS SWITCH (OPTION -01)
08	02	OXYGEN OUTLET DISTRIBUTOR MODULE/ASSY.
09	02	OXYGEN OUTLET DISTRIBUTOR UNIT SHIELDED INTERFACE CABLE
10		
11		
12	01	MULTI-CONDUCTOR SHIELDED INTERFACE CABLE TO RCVR/OR
13	20'	(RED) 4 mm. POLYURETHANE OXYGEN TUBE FROM BYPASS SWITCH (OPTION -01)
14	20'	(GRN) 6 mm. POLYURETHANE MAIN OXYGEN TUBE
15	01	UNION TEE FOR 4 mm POLYURETHANE OXYGEN TUBE (OPTION -01)
16	01	IPR OXYGEN REGULATOR ASSY. WITH OXYGEN CYLINDER
17	01	REMOTE OXYGEN FILL STATION, TUBING & FITTINGS (BULKHEAD TYPE SHOWN)
18	20'	1/8" OD. COPPER, ALUM. OR STAINLESS OXYGEN TUBE TO FILL STATION
19	20'	1/8" 3 mm. POLYURETHANE OXYGEN TUBE TO BYPASS SWITCH
20	01	UNION TEE FOR 6 MM. FOR MAIN POLYURETHANE OXYGEN TUBE
21	01	(GRN) 6 MM. OXYGEN INLET SERVICE BARB
22	01	(RED) 4 MM. OXYGEN INLET SERVICE BARB (EMERGENCY BYPASS)
23		
24		
25		
26		

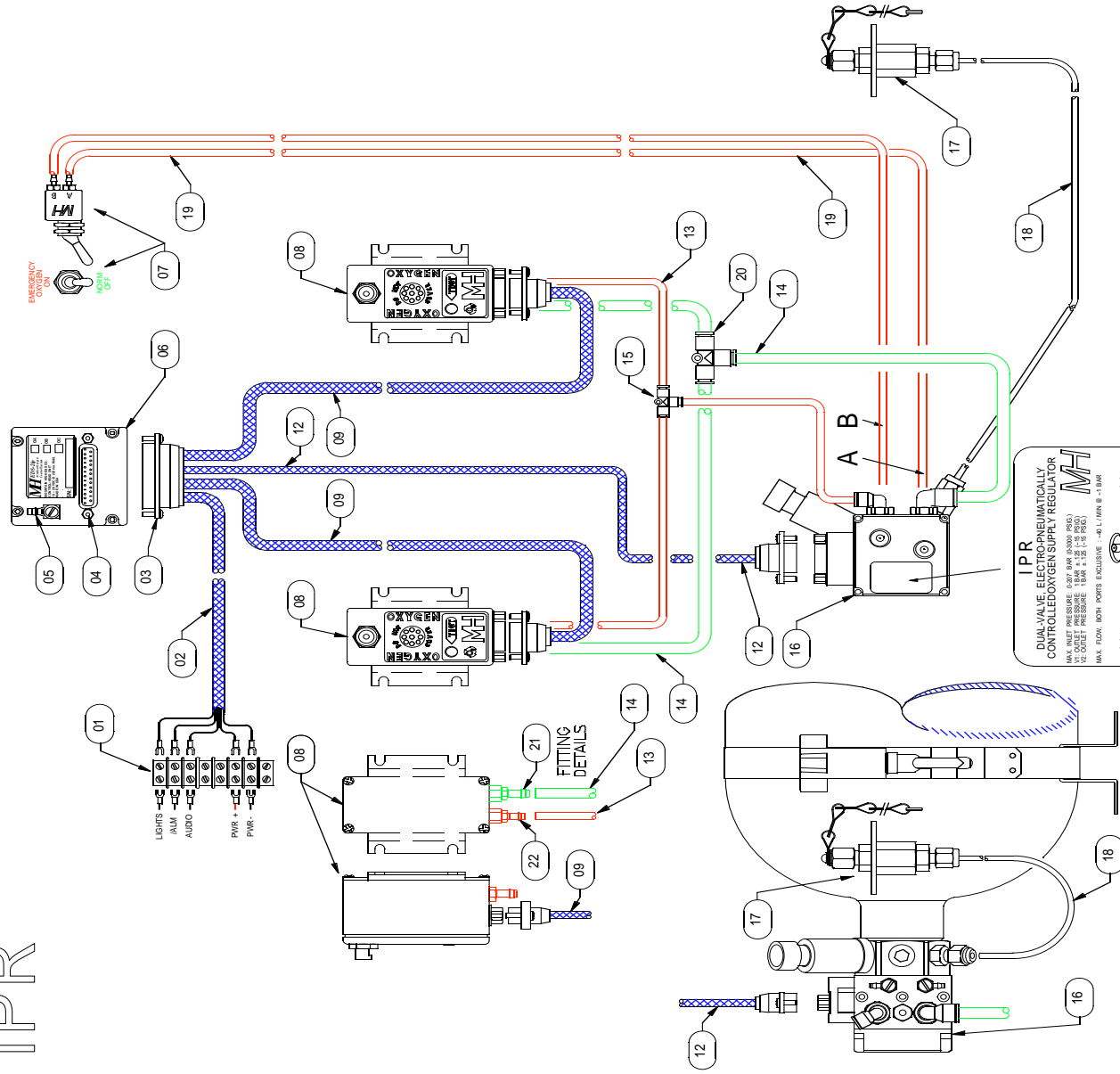

2 ip

THIRD ANGLE PROJECTION

(KC) NUMBER OF KEY CHARACTERISTICS IN THIS DRAWING / DOCUMENT PER PART DOC: ESR-001

MH MOUNTAIN HIGH EKS CO. REDMOND, OR, USA

EDS-2IP PHYSICAL SCHEMATIC-IPR

ISSUED: PLM
 ENGINEER: PLM
 APPR:

DWG. #: EDSIP-051-001
 SIZE: B
 SHEET 1 OF 1

DO NOT SCALE DRAWING

Zip & 4ip control head DB-25 Electrical Connection Legend FOR USE WITH IPR

CONTROL-HEAD DB-25
GND CONNECTOR PINS
2, 3, 14, 15 & 16
FOR SYSTEM GROUND
ARE TIED TOGETHER IN
THE CONTROL HEAD AND
ARE INTERCHANGABLE

NOTICE !

CONTROL-HEAD DB-25
+10V CONNECTOR PINS
4, 5, 17, 18 & 19
ARE TIED TOGETHER IN
THE CONTROL HEAD AND
ARE INTERCHANGABLE

AVIONICS BUS
+14 to +28 VDC

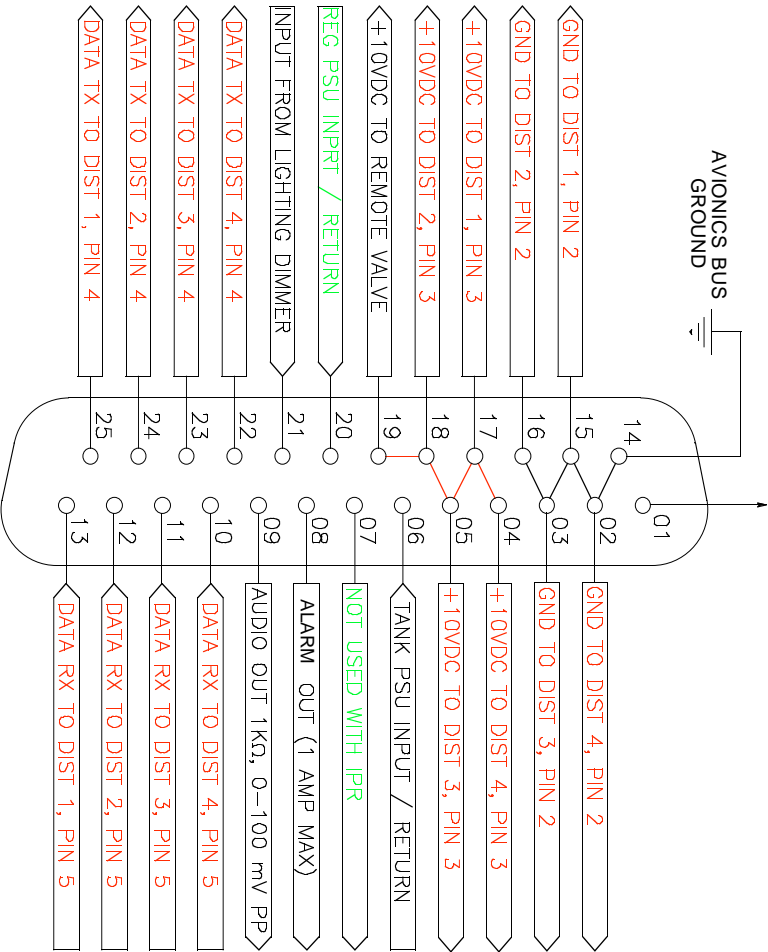

PIN	PIN FUNCTION
01	AVIONICS BUS +12 TO +28 VDC
02	GROUND TO DISTRIBUTOR 4, PIN 2 (4ip ONLY)
03	GROUND TO DISTRIBUTOR 3, PIN 2 (4ip ONLY)
04	+10 VDC TO DISTRIBUTOR 4, PIN 3 (4ip ONLY)
05	+10 VDC TO DISTRIBUTOR 3, PIN 3 (4ip ONLY)
06	INPUT / RETURN FROM TANK PRESSURE SENDING UNIT (PSU), PIN 5
07	NOT USED IF USING THE IPR REGULATOR
08	GROUND SUPPLY FOR ALARM (1 AMP MAX.)
09	AUDIO OUTPUT (1 KΩ @ 0 - 100 mv PP)
10	DATA RX TO DISTRIBUTOR 4, PIN 5 (4ip ONLY)
11	DATA RX TO DISTRIBUTOR 3, PIN 5 (4ip ONLY)
12	DATA RX TO DISTRIBUTOR 2, PIN 5
13	DATA RX TO DISTRIBUTOR 1, PIN 5
14	AVIONICS BUS GROUND
15	GROUND TO DISTRIBUTOR 1, PIN 2
16	GROUND TO DISTRIBUTOR 2, PIN 2
17	+10 VDC TO DISTRIBUTOR 2, PIN 3
18	+10 VDC TO DISTRIBUTOR 1, PIN 3
19	+10 VDC SUPPLY TO REMOTE VALVE SOLINOID COIL / VALVE, PINS 2 & 9
20	INPUT FROM REGULATOR PRESSURE GAUGE (OPTIONAL ITEM)
21	INPUT FROM PANEL LIGHTING DIMMER
22	DATA TX TO DISTRIBUTOR 4, PIN 4 (4ip ONLY)
23	DATA TX TO DISTRIBUTOR 3, PIN 4 (4ip ONLY)
24	DATA TX TO DISTRIBUTOR 2, PIN 4
25	DATA TX TO DISTRIBUTOR 1, PIN 4

REVISION HISTORY		NOTES
REV	DA-MO-YR	E. C. O. / APPR
A	06-05-05	PLM
B	05-03-06	PLM
C	14-11-08	PLM

Audio output is microphone compatible

ISSUED:	DA-MO-YR	FIGS ANGLE PROJECTION	(K) NUMBER OF REV CHARACTERISTICS IN THIS DRAWING / DOCUMENT
DRAWN:	PLM	04-07-03	00
ENGINEER:	PLM	DATE	PER MH DOC: ESR-001
APPR:	DATE	DATE	
EDS-IP CONNECTOR ASSIGNMENT		MOUNTAIN HIGH E&S CO. REDMOND, OR, USA	
DWG. #	EDSIP-051-003	REV	C
SIZE	A	SHEET	1 OF 1
DO NOT SCALE DRAWING			

Basic Theory of the EDS technology

The EDS (Electronic Delivery System) utilizes well known human respiratory physiological facts to provide the most efficient, yet smallest and lightest aviation oxygen system available. The EDS monitors micro-pressure changes in human breathing, delivering a precise pulse of oxygen at the instant each inhaling cycle is detected. Precious oxygen that is otherwise lost (over constant flow systems) is saved by using the pulse-demand system. Oxygen is not wasted during times it is not needed with the EDS pulse-demand system. Because constant flow systems simply spill excessive amounts of precious oxygen, many pilots wait until some indication of hypoxia is detected before they begin to use what supply of oxygen they may have. If a person does not recognize the indications of hypoxia, it can result in their being well behind the oxygen saturation curve from the start resulting in serious judgment flaws.

Each station distributor is an independent oxygen delivery unit constantly gathering respiratory physiological information of each person. A respiration profile is then made for each person connected. Operating modes, pressure altitude, exposure factor (rate of ascent & duration) and cylinder pressure information are also gathered from the control head to provide information to provide true physiological adaptiveness.

The EDS system has the ability to virtually monitor and profile the physiological aspects of each person connected. In fact O₂ saturation can be estimated by respiratory profiling. The EDS-ip (intelligent peripheral) system provides the correct amount of O₂ for various exposure factors at altitudes for various types of persons at all times, while using only the amount of oxygen needed to help yield correct oxygen saturation factors.

The patented 'synchronous inhalation pulse-demand technique' used by the EDS is currently the most efficient way, known by respiratory physiologists, to saturate the blood to well over 90%, while using as little as 1/8 the oxygen over standard constant-flow systems. The average user may see a of 6 to 8 times savings because of adaptation factors.

Since its introduction in 1992, the EDS Pulse-Demand delivery method of administering O₂ to an individual at various altitudes has set new standards in the Aviation SBA (Supplementary Breathing Apparatus). The EDS-2ip and 4ip are complete two & four-place Pulse-Demand aviation oxygen systems that can be built into instrument panels or overhead consoles in a variety of aircraft.

Physiological Factors

The breathing cycle of a normal healthy, non-smoking, person is such that about one-third is spent inhaling while two-thirds is spent exhaling and pausing. In addition, the human lungs, for their size, are relatively inefficient compared to other organs. The human lungs are easily stressed at high altitudes, affecting the entire body within seconds. This is partly because only a fraction of inhaled air (25% to 30%) actually gets to the O₂ & CO₂ exchange area of the lungs. The rest is spent in the 'dead-space' areas such as the trachea, bronchus, and other areas not directly contributing to oxygen absorption. Then the air, with this O₂, is simply exhaled back out. Studies have shown that one greatly benefits from the pulse-demand method of O₂ being delivered at the very beginning of inhalation cycles. With this, the O₂ flows into the most functional part of the lungs, allowing optimum oxygen absorption during high altitude excursions.



**The EDS-ip technology
is engineered and
made in the USA**



General Specifications of the EDS-ip systems

Specifications, performance standards and limits are derived from actual units tested, characterized or calculated.
Specifications are subject to change without notice.

Operating Voltage (pin 1): 11 - 32 VDC. Automatic voltage selecting for 14 or 28 volt systems.
Reverse voltage protection: Series Shotkey type Diode

Currents below are measuring a Zip control head and two DIST units only and do not include any currents expressed by the electronic pressure sending units or IPR. (Add ~ 75 ma. to include IPR & ~ 20 ma. MAX for each sending unit)

Operating Current @ 14 VDC (OFF 'standby state'): ~ 19 ma. (~22 ma. with lights on full)
Operating Current @ 14 VDC (ON): ~50 ma Avg. ~ 164 ma. peak (including initial turn-on phase)
Operating Current @ 14 VDC (ON with two stations breathing @ 10 K ft.): ~50 ma Avg. ~116 ma. peak. (lights on or off)

Operating Current @ 28 VDC (OFF 'standby state'): ~ 11 ma. (~13 ma. with lights on full)
Operating Current @ 28 VDC (ON): ~28 ma Avg. ~ 92 ma. peak (including initial turn-on phase)
Operating Current @ 28 VDC (ON with two stations breathing @ 10 K ft.): ~28 ma Avg. ~68 ma. peak. (lights on or off)

Operating Current for IPR: ~75 ma @ 10 VDC (powered from control head via DIST power)

DIST power outputs (pins 4, 5, 17, 18 & 19) +10 VDC @ 2 Amps MAX. On only while system is active.

Gauge inputs (pins 6 & 20): 4-20 ma. into a 25 Ω @ 100 nf load to ground @ 10 - 32 VDC (across sending unit).
Gauge range: Tank Pressure 0 - 3,150 psig., regulator pressure 0 - 31.5 psig., PA 0 - 31.5 K ft.

Lights input (pin 29): 0 to 14 or 28 VDC loaded into 15K Ω / 100nf load to ground. 0 - 14 or 0 -28 VDC.

Audio output (pin 9): 0 to 100 mV PP @ ~1,000 Ω (microphone level compatible)

Alert / Alert drive (pin 8): Normally open ground-start contact (solid-state relay) to ground @ 3 Amps MAX.

RCV / IPR drive (pin 7) Normally open ground-start contact (solid-state relay) to ground @ 3 Amps MAX.

Data communications TX to DIST units (pins 22, 23, 24 & 25): RS-232 levels.

Data communications RX from DIST units (pins 10, 11, 12 & 13): RS-232 levels.

Operating temperature, humidity, vibration & shock (assumes nominal operating voltage):

Minimum: 0% RH @ -40° C to +60° C. (LCD readability not guaranteed @ extremes)
Nominal: 25% RH @ +25° C.
Maximum: 100% RH @ +50° C. near condensing. (Unit is not water-proof)
Vibration: Random vibration 5 to 500 Hz, 15 minutes per axis @ 4.0 g. (rms.) sine wave.

Dist units operating inlet pressures:

DYNAMIC 1 bar (15 psig.) (flowing) through cannula and DIST unit
STATIC (non-flowing) 2.2 bar (35 psig) MAX.

Allowable respiration rates:

Adaptive: 0-10K ft. = 20 BPM, 12-20K ft. = 22 BPM, 21 through 25K ft. = 25 BPM, 26 and over = 30 BPM, Fixed @ 30 BPM if PA is past 30 K ft.

Apnea 'time-out' envelope:

Adaptive: ~40 sec Pa. 0-12 K ft., ~30 sec. Pa. 13-18 K ft., 20 Sec. at and above Pa. 18 K ft.



 Aviation Oxygen Systems
MOUNTAIN HIGH
 Equipment & Supply Company

2244 S.E. AIRPORT WAY, SUITE 100. Redmond, OR. 97756-7537 U S A
 800-468-8185 World Voice: 541-923-4100 World Fax: 541-923-4141 www.mhoxygen.com